NOUVEAUX PRODUITS 2023



DIA EDGE



 MITSUBISHI MATERIALS

NOUVEAU SYSTÈME POUR LES CATALOGUES

COMMENT ACTUALISER VOTRE CATALOGUE

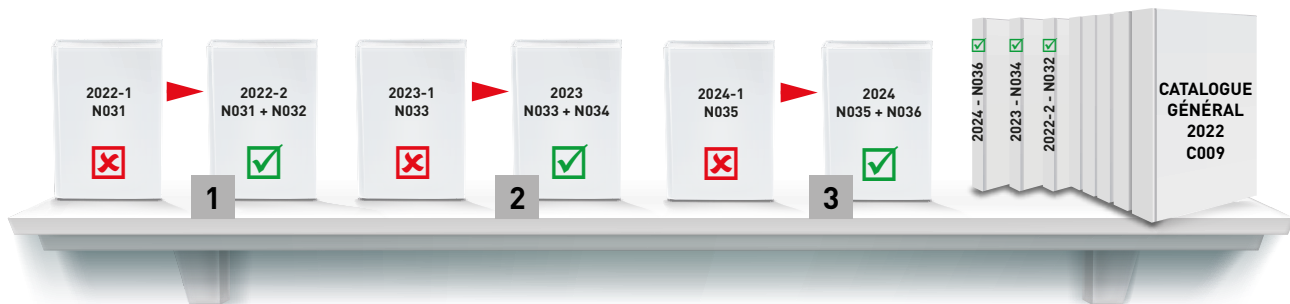

NOTE :

- 1 Le catalogue Nouveautés 2022-1 – N031 a été intégré au catalogue Nouveautés 2022-2 – N032.
- 2 La brochure des Nouveautés 2023-1 – N033 sera intégrée au catalogue Nouveautés 2023 – N034.
- 3 La brochure des Nouveautés 2024-1 – N035 sera intégrée au catalogue Nouveautés 2024 – N036.

Les catalogues annuels de nouveautés (N032, N034, etc...) trouveront leur place dans la boîte du CATALOGUE GÉNÉRAL existante.

La brochure des Nouveautés, dont la référence se termine par -1, peut être sortie de la boîte après publication du catalogue annuel des Nouveautés.

ÉVOLUTION DU CATALOGUE GÉNÉRAL



NOTE :

Les catalogues Nouveautés annuels (N032, N034, etc..) seront intégrés au futur CATALOGUE GÉNÉRAL.



NEW

NOUVEAUX PRODUITS 2023

NOUVEAUX PRODUITS ET EXTENSIONS DE GAMME EN UN SEUL VOLUME

Mitsubishi Materials met en permanence l'accent sur les besoins spécifiques de ses clients pour mieux répondre aux attentes de l'industrie métallurgique d'aujourd'hui. Ce catalogue contient tous les nouveaux produits et extensions de gamme de la marque DIAEDGE pour le tournage, le fraisage et le perçage.

MODERNE, INNOVANT, COMPÉTITIF





NOTE : Cette brochure des Nouveautés 2023 (N034) complète le CATALOGUE GÉNÉRAL et le catalogue des Nouveautés 2022-2 (N032).

Il contient les nouveaux produits et les extensions de gamme lancés depuis l'édition des catalogues N032 et C009.

Nous nous réservons le droit d'apporter des modifications à tout article présenté dans ce catalogue, comme par exemple les données techniques, l'élaboration, l'équipement fourni, le matériau et l'apparence. Toutes les dimensions sont exprimées en millimètres. La dernière version du catalogue est disponible sur le site : www.mmc-carbide.com

SOMMAIRE

OUTILS DE TOURNAGE

NEW	MC6100	6
2023	Extension de gamme : Plaquettes ISO positives pour une grande gamme d'applications, nuances MC6115 pour l'usinage à haute vitesse et MC6125 polyvalente.	
NEW	GY	26
2023	Porte-outils de décolletage GY monobloc.	
2022-2	Plaquette GY 1.2 mm et porte-outil monobloc pour le décolletage. Plaquettes GY de 1.5 mm/2 mm/2.5 mm/3 mm avec des angles d'attaque de 8° et 15°.	
NEW	MP/MT9000	46
2023	Plaquettes ISO pour titane et réfractaires. Extension de gamme : Plaquettes négatives rectifiées avec brise-copeaux FS et LS.	
	MP/MT9000	
2022-1	Plaquettes de tournage ISO pour titane et réfractaires. MP9025 – Nuance PVD, extension de gamme plaquettes positives à 7° pour les matières ISO-S.	
NEW	MS7025/ MS9025	53
2023	Extension de gamme des plaquettes positives de décolletage.	
	MS7025	
2022-2	Nuance PVD pour le décolletage d'acier inoxydable.	
	SÉRIE MC5100	67
2023-1	Nuances de tournage fonte, optimales pour toutes les applications, de la coupe à haute vitesse à l'usinage au choc.	
	BC8220	
2022-1	Nuance CBN polyvalente pour le tournage d'aciers traités et trempés. Nouveau brise-copeaux BR pour un excellent contrôle du copeau en enlèvement de couches cémentées, dures et des profondeurs de passe allant jusqu'à 1 mm.	
	GW	
2022-1	Extension de gamme : Porte-outils monobloc et plaquette de 2.39 mm. Différents brise-copeaux à 5° et 8°.	

FRAISES MONOBLOC / A EMBOUT VISSÉ

NEW	VFR	82
2023	VFR4MB – Fraise hémisphérique 4 dents pour les aciers traités de haute dureté.	
	VFR	
2022-1	Extension de gamme VFR2XLB – Fraises de finition longues pour moules et matrices.	
	SÉRIE MP	88
2023-1	MP3C – Fraise à chanfreiner 3 dents, pour une forte productivité et une grande durée de vie.	

VQ SERIES

- 2022-2 VQJCS/VQLCS – Nouvelle fraise monobloc avec brise-copeaux, géométrie pas variable.
 2022-1 VQN4/6MVRB – Fraises toriques pour les alliages réfractaires à base nickel.

**iMX**

- 2022-2 iMX-C6HV-C – Fraise torique avec arrosage central, 6 dents, hélice variable.



FRAISES À PLAQUETTES

NEW**FMAX**

- 2023 FMAX-MB – Corps à pas large pour pièces de petite taille et applications de faible raideur.

95

NEW**WWX**

- 2023 WWX200 – Extension de gamme : brise-copeaux L.
 2023-1 WWX200 – Un nouveau niveau de polyvalence.
 Fraise à surfacer-dresser de haute performance, nouvelles plaquettes de taille 09, plaquettes trigones réversibles.
 WWX400 – Extension des plaquettes à brise-copeaux M.
 Grands rayons de plaquette (RE 1.6/2.0) et plaquette de planage.

102

AXD

- 2023-1 AXD4000 – Corps à visser, pour l'usinage à grande vitesse des alliages d'aluminium.

119

WSF406W

- 2022-2 Nouveau brise-copeaux M et Wiper.
 2022-1 Plaquette réversible à géométrie positive une faible prise de puissance.
 Usinage à haut rendement de la fonte.

**AJX**

- 2022-1 Nouveaux corps à alésage et cylindriques en pas extra-fin.
 Extension de la gamme grande avance.



OUTILS DE PERÇAGE

NEW**DFAS**

- 2023 Foret carbure monobloc à fond plat avec trous d'arrosage.
 Hautes performances pour une large gamme d'applications.

130

DSAS

- 2022-2 Nouvelles dimensions de forets carbure monobloc DSAS avec arrosage interne pour matériaux réfractaires.

**MINI DVAS**

- 2022-2 Nouvelle série de forets carbure monobloc TRISTAR.
 Rapide, fiable et précis.



MPLUS OUTILS

NEW**415SD**

- 2023 Fraise à grande avance pour les alliages de titane.

139

SÉRIE MC6100

NUANCES DE TOURNAGE ACIER CVD
POUR L'USINAGE À HAUTE VITESSE

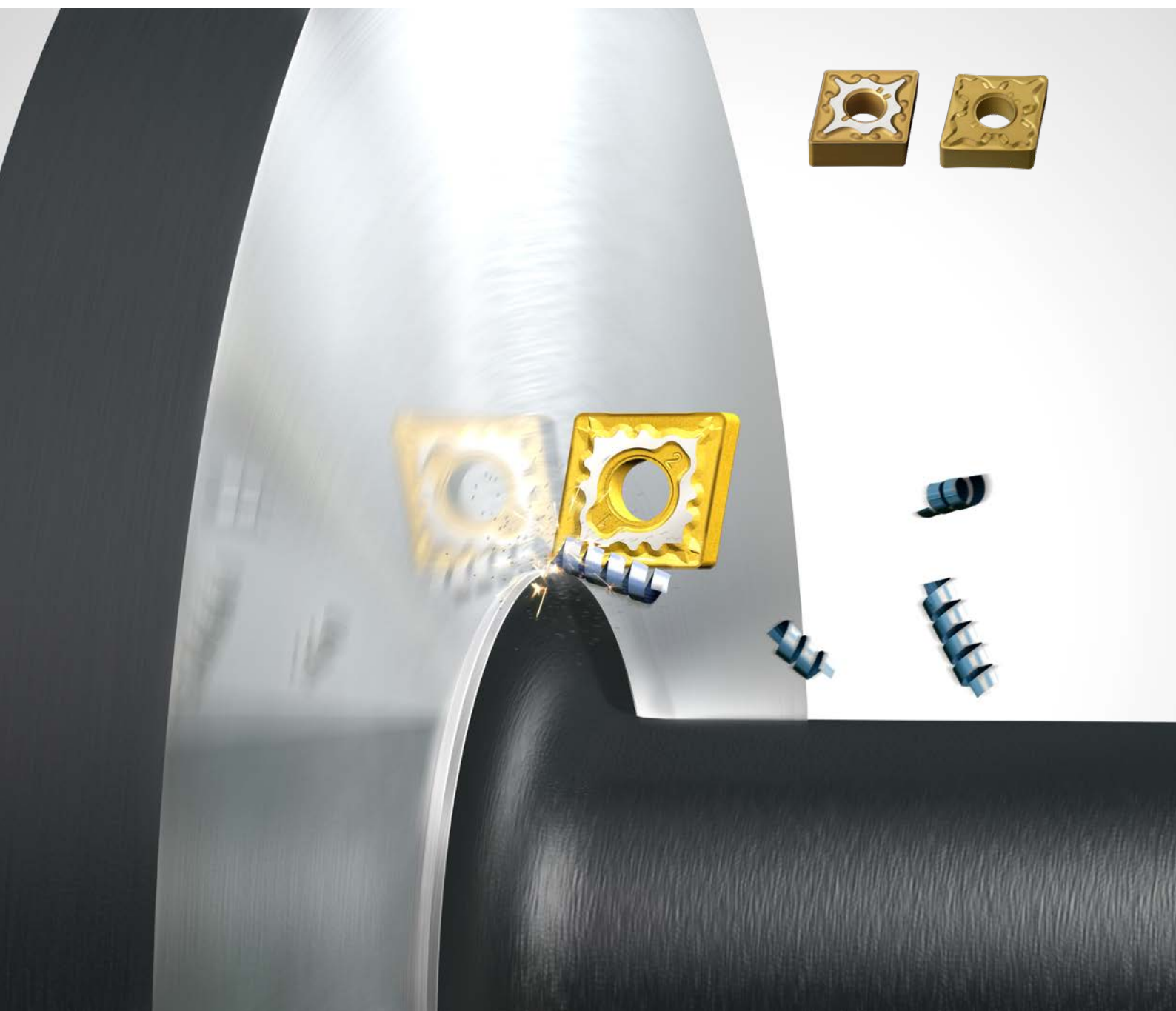

En savoir plus...

B266

www.mhg-mediastore.net



SÉRIE MC6100

NUANCES DE TOURNAGE ACIER CVD

Résistance à l'usure et à l'écaillage améliorées par des revêtements de dernière génération.

MC6115

P10 - Pour le tournage à grande vitesse

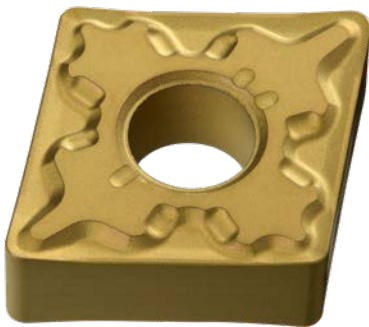

MC6125

P20 - Nuance polyvalente

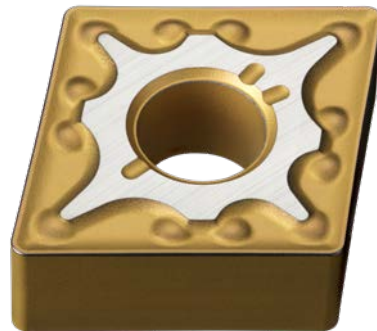

„SUPER“ NANO TEXTURE

La technologie de nano-texturation standard a été grandement améliorée, le revêtement Al_2O_3 Mitsubishi Materials est la nouvelle référence du marché. La durée de vie est augmentée de manière significative grâce à la finesse et à l'orientation des cristaux de revêtement.

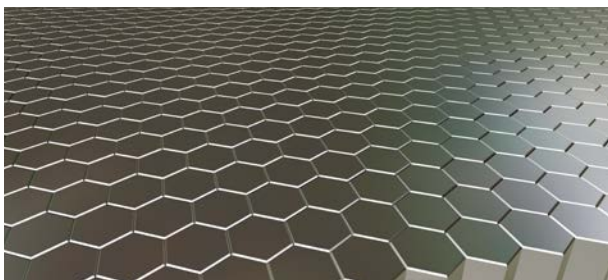

ORIENTATION CRISTALLINE (Représentation graphique)



Plaquettes CVD conventionnelles

La taille et l'orientation des grains sont inégales.

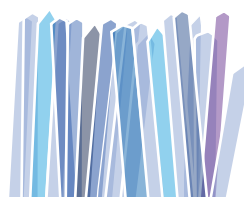

Nano-revêtement

L'homogénéité de taille et d'orientation des grains est améliorée.



Super nano-revêtement

L'homogénéité de taille et d'orientation des grains est considérablement améliorée.

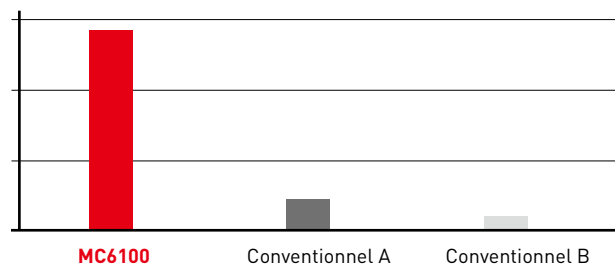

Teneur en grains d' Al_2O_3 avec la même orientation

SÉRIE MC6100

RÉSISTANCE À L'ÉCAILLAGE

RÉSISTANCE À L'ÉCAILLAGE RENFORCÉE

La fissuration provoquée par un usinage interrompu est évitée grâce à la réduction des contraintes de traction dans le revêtement. Dans la série MC6100, les contraintes de traction ont été réduites de 80 % par rapport aux plaquettes CVD conventionnelles.

RÉDUCTION DE L'EFFORT DE TRACTION

Choc pendant l'usinage

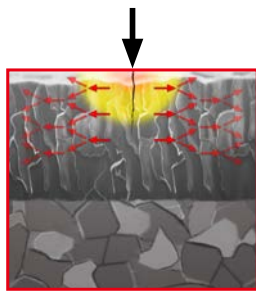

Effort de traction réduit

Série MC6100

La série MC6100 présente un niveau de contrainte beaucoup plus faible que les revêtements CVD conventionnels grâce au traitement de surface. Cela réduit l'intensité des impacts pendant l'usinage et protège la plaquette contre l'écaillage.

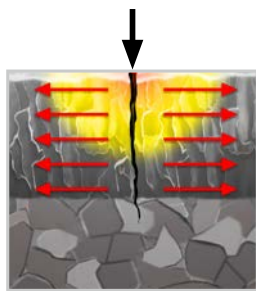

Effort de traction important

Plaquette CVD conventionnelle

Des fissures sont amorcées à la surface de la plaquette par les chocs. Elles se propagent à travers le revêtement vers le substrat en raison de l'important effort de traction dans le revêtement. Cela amène des écaillages de l'arête.

SUPER-TOUGH-GRIP

La couche d'accroche Super Tough-GRIP est composée de cristaux fins qui renforcent l'adhésion entre les couches de revêtement.

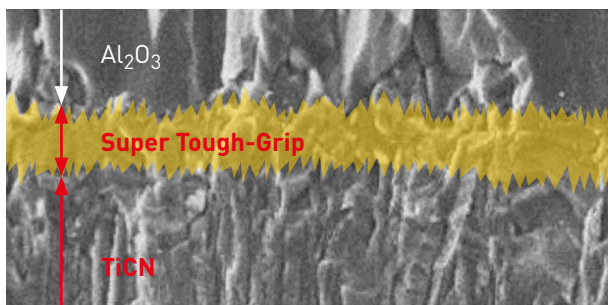

(Représentation graphique)

Force d'adhésion*

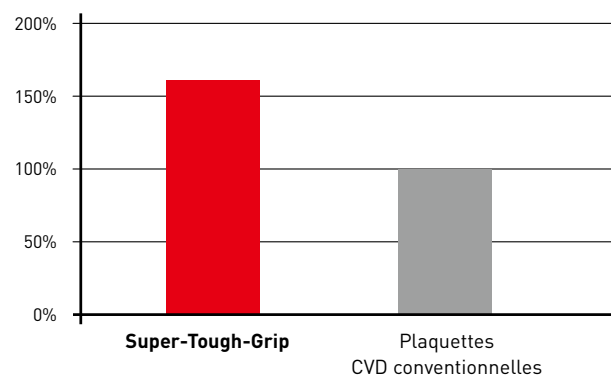

*La mesure de la force d'adhésion est obtenue par un test de quadrillage.

MC6115

DURÉE DE VIE ET PRODUCTIVITÉ AUGMENTÉES PAR UNE AMÉLIORATION SIGNIFICATIVE DE LA RÉSISTANCE À L'USURE ET À LA CHALEUR

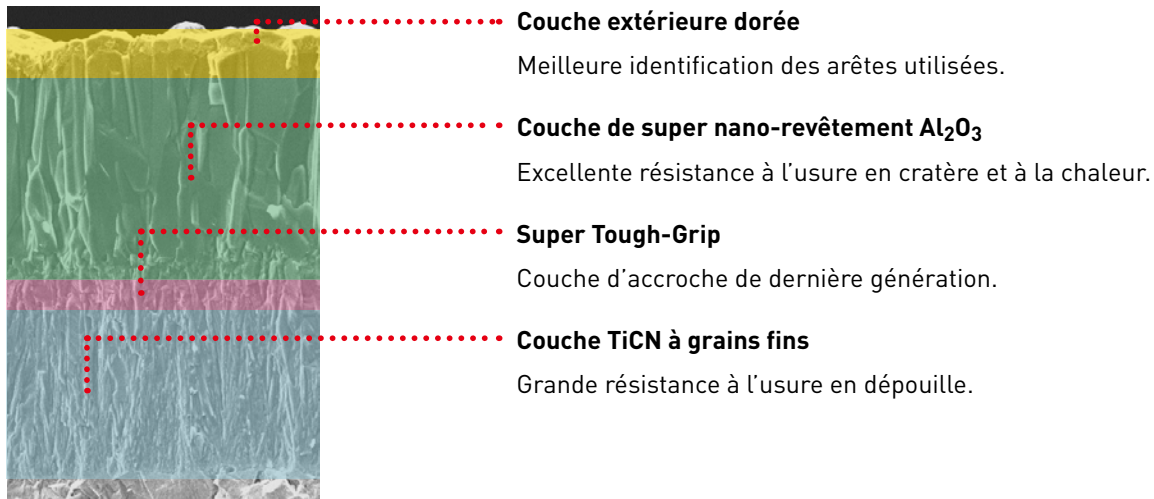

NOUVELLE COUCHE DE REVÊTEMENT SUPÉRIEURE

La couche extérieure de MC6115 limite le collage des copeaux, améliorant ainsi la tenue de cote et l'état de surface des pièces. La couleur dorée permet d'identifier facilement les arêtes utilisées.

EXEMPLE D'USINAGE : 20MC5

COMPARAISON DE LA RÉSISTANCE À L'USURE

Matière	20MC5 170HB
Plaquette	CNMG120408-MH
Vc (m/min)	200
f (mm/tr)	0.3
ap (mm)	1.5
Arrosage	Usinage à sec

Résultats

Avec une nuance conventionnelle, le collage dégrade rapidement la plaquette. Ce type d'usure est efficacement évité avec la nuance MC6115.

APRÈS 2 MINUTES D'USINAGE D'ACIER ALLIÉ



MC6115
Brise-copeaux MH



Plaquette CVD conventionnelle

MC6125

NUANCE POLYVALENTE POUR L'ACIER - AUGMENTATION DE LA DURÉE DE VIE ET PERFORMANCES STABLES SUR UNE PLUS LARGE GAMME D'APPLICATIONS

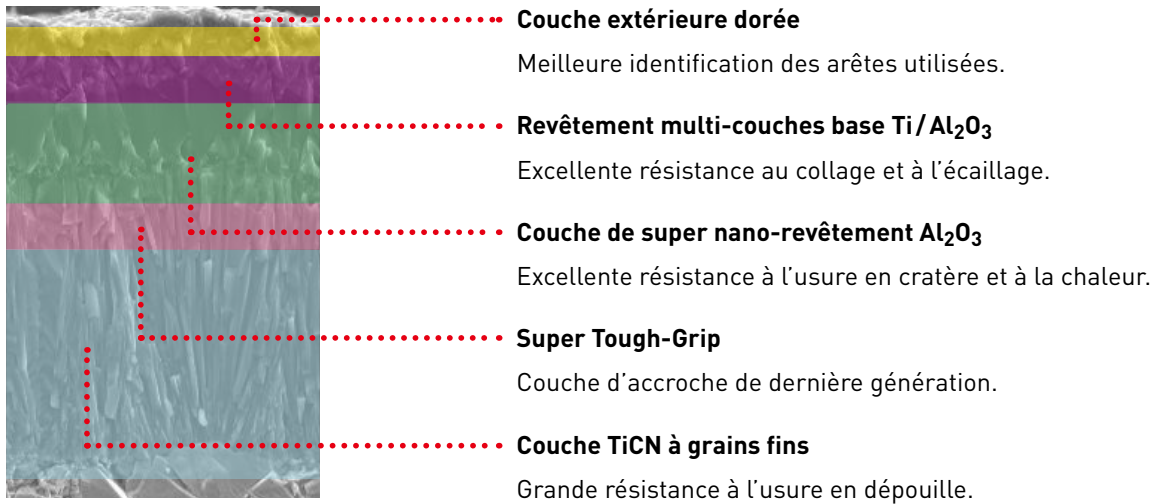

TRAITEMENT DE SURFACE

MC6125 utilise un nouveau traitement de surface pour une résistance accrue à l'écaillage et au collage. Ce traitement permet l'utilisation de la nuance MC61125 pour une plus vaste gamme d'applications.

EXEMPLE D'USINAGE : XC48

COMPARAISON DE LA RÉSISTANCE À L'USURE



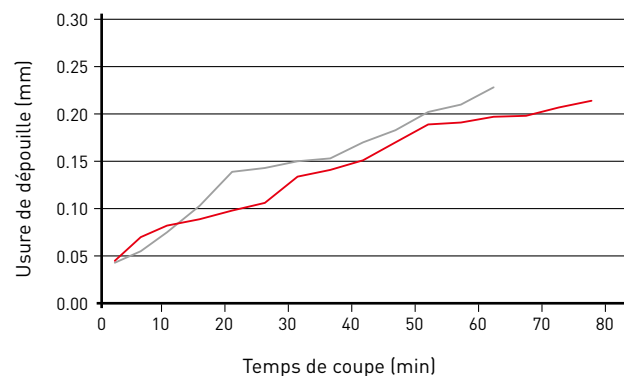







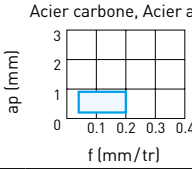
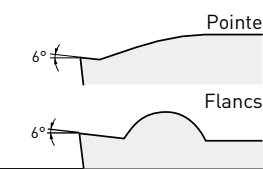

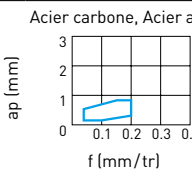
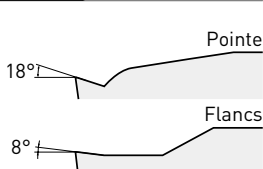

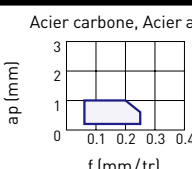
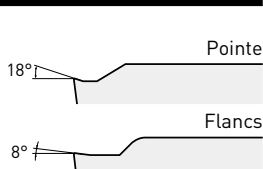

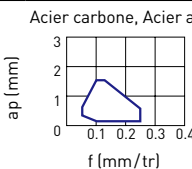
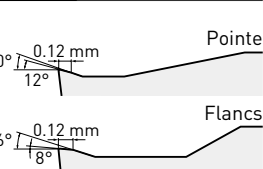
Matière	XC48
Plaquette	CNMG120408-MH
Vc (m/min)	200
f (mm/tr)	0.3
ap (mm)	1.5
Arrosage	Huile soluble
Résultats	Le traitement de surface a permis d'améliorer la stabilité et de prolonger la durée de vie de l'outil.

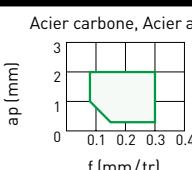
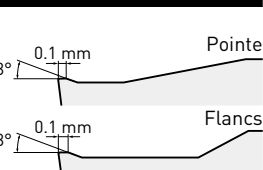

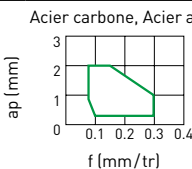
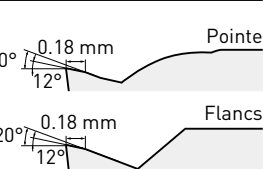
SÉRIE MC6100

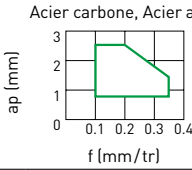
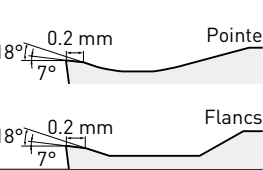
BRISE-COPEAUX POUR LE TOURNAGE DE L'ACIER

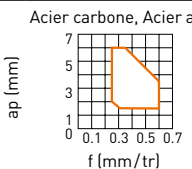
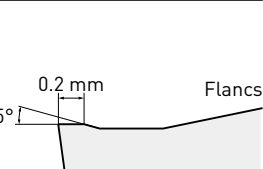

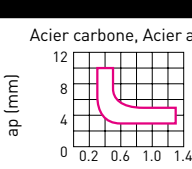
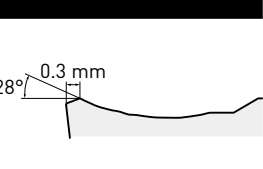
PLAQUETTES POSITIVES 5°, 7°

Tolérance	Caractéristiques	Géométrie de coupe
FINITION		
M	 <p>PREMIER CHOIX POUR LA FINITION DES ACIERS AU CARBONE, ALLIÉS ET DOUX La protubérance du brise-copeaux au centre du rayon contrôle les copeaux même à faible profondeur de passe. Bonne résistance à l'écaillage du rayon</p> <p>FP</p>	<p>Acier carbone, Acier allié</p>  
	 <p>BRISE-COPEAUX ALTERNATIF POUR LA FINITION DES ACIERS AU CARBONE, ALLIÉS, DOUX ET INOXYDABLES Pour les faibles profondeurs de passe et avances. La grande acuité d'arête réduite les efforts de coupe et permet ainsi d'excellentes performances.</p> <p>FV</p>	<p>Acier carbone, Acier allié</p>  
COUPE LÉGÈRE		
M	 <p>PREMIER CHOIX POUR LA COUPE LÉGÈRE DES ACIERS AU CARBONE, ALLIÉS ET DOUX Bonne acuité d'arête grâce au grand angle de coupe. Évite le collage et le matage de surface. La protubérance du brise-copeaux optimisée assure un contrôle du copeau fiable.</p> <p>LP</p>	<p>Acier carbone, Acier allié</p>  
	 <p>PLAQUETTE RACLEUSE POUR LES ACIERS AU CARBONE, ALLIÉS, DOUX ET INOXYDABLES Par rapport à une plaquette conventionnelle, un bon état de surface est assuré même à forte avance. Le témoin positif assure une bonne acuité.</p> <p>SW</p>	<p>Acier carbone, Acier allié</p>  
COUPE MOYENNE		
M	 <p>PREMIER CHOIX POUR LA COUPE MOYENNE DES ACIERS AU CARBONE, ALLIÉS ET DOUX Bon équilibre des résistances à l'usure et à l'écaillage grâce au témoin plat. La grande poche à copeaux réduit les efforts de coupe et les risques de vibrations et de bourrage de copeaux, même pour des profondeurs de passe importantes.</p> <p>MP</p>	<p>Acier carbone, Acier allié</p>  
	 <p>BRISE-COPEAUX ALTERNATIF POUR LA COUPE MOYENNE DES ACIERS AU CARBONE, ALLIÉS, DOUX ET INOXYDABLES Grand angle de coupe pour des performances d'arête optimales. Le double brise-copeaux et la forme arrondie sur la face de coupe assurent un excellent contrôle du copeau.</p> <p>MV</p>	<p>Acier carbone, Acier allié</p>  
	 <p>PLAQUETTES RACLEUSE POUR LA COUPE MOYENNE DES ACIERS AU CARBONE, ALLIÉS, DOUX ET INOXYDABLES La plaquette racleuse permet une avance jusqu'à deux fois supérieure. La grande poche à copeaux empêche le bourrage.</p> <p>MW</p>	<p>Acier carbone, Acier allié</p>  
	 <p>BRISE-COPEAUX ALTERNATIF POUR LA COUPE MOYENNE DES ACIERS AU CARBONE, ALLIÉS, DOUX, INOXYDABLES ET FONTES Équilibre entre résistance et acuité d'arête par la combinaison d'un témoin plat et d'un grand angle de coupe.</p> <p>Standard</p>	<p>Acier carbone, Acier allié</p>  
ÉBAUCHE		
M	 <p>BRISE-COPEAUX D'ÉBAUCHE POUR LES ACIERS AU CARBONE ET ALLIÉS Le brise-copeaux à grande gorge empêche le bourrage des copeaux à grande profondeur de passe. Les petites encoches améliorent le contrôle des copeaux à de faibles profondeurs de coupe.</p> <p>RR</p>	<p>Acier carbone, Acier allié</p>  







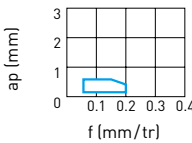
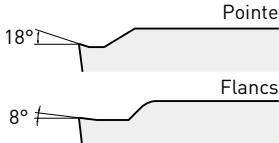

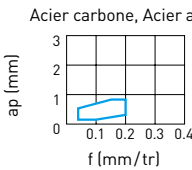
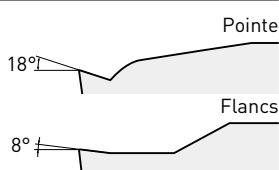

SÉRIE MC6100

BRISE-COPEAUX POUR LE TOURNAGE DE L'ACIER

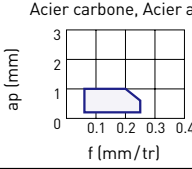
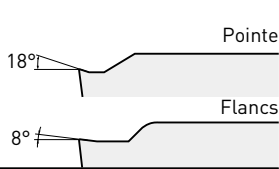
PLAQUETTES POSITIVES 7°

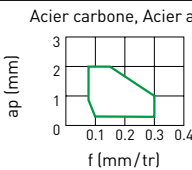
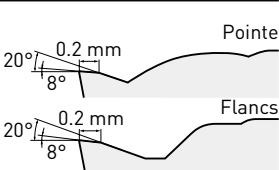
Tolérance	 Caractéristiques	Géométrie de coupe
	FINITION	
M	 <p>BRISE-COPEAUX DE COPIAGE POUR LES ACIERS AU CARBONE ET ALLIÉS Le contrôle du copeau est assuré par une géométrie de copiage spécifique.</p> <p style="text-align: center;">SVX</p>	<p>Acier carbone, Acier allié</p>  

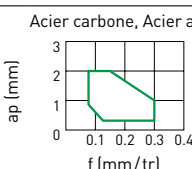
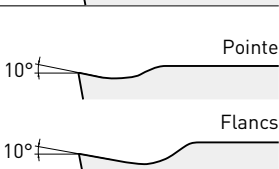
PLAQUETTES POSITIVES 11°

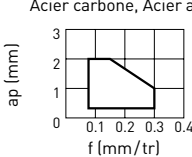
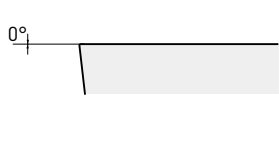
Tolérance	 Caractéristiques	Géométrie de coupe
	FINITION	
M	 <p>PREMIER CHOIX POUR LA FINITION DES ACIERS AU CARBONE, ALLIÉS, DOUX ET INOXYDABLES Pour les faibles profondeurs de passe et avances. La grande acuité d'arête réduit les efforts de coupe et permet ainsi d'excellentes performances.</p> <p style="text-align: center;">FV</p>	<p>Acier carbone, Acier allié</p>  
COUPE LÉGÈRE		
M	 <p>PREMIER CHOIX POUR LA COUPE LÉGÈRE DES ACIERS AU CARBONE, ALLIÉS ET DOUX Bonne acuité d'arête grâce au grand angle de coupe. Évite le collage et le matage de surface. La protubérance du brise-copeaux optimisée assure un contrôle du copeau fiable.</p> <p style="text-align: center;">LP</p>	<p>Acier carbone, Acier allié</p>  
COUPE MOYENNE		
M	 <p>PREMIER CHOIX POUR LA COUPE MOYENNE DES ACIERS AU CARBONE, ALLIÉS, DOUX, INOXYDABLES ET FONTES Grand angle de coupe pour des performances d'arête optimales. Le double brise-copeaux et la forme arrondie sur la face de coupe assurent un excellent contrôle du copeau.</p> <p style="text-align: center;">MV</p>	<p>Acier carbone, Acier allié</p>  
M	 <p>BRISE-COPEAUX ALTERNATIF POUR LA COUPE MOYENNE DES ACIERS AU CARBONE, ALLIÉS ET INOXYDABLES Brise-copeaux standard pour un usage général.</p> <p style="text-align: center;">Standard</p>	<p>Acier carbone, Acier allié</p>  
PLAQUETTE PLATE		
M	 <p>PLAQUETTE PLATE Sans brise-copeaux. Grande fiabilité en usinage instable en raison de la grande résistance d'arête.</p> <p style="text-align: center;">Sans brise-copeaux</p>	<p>Acier carbone, Acier allié</p>  

VBMT, WBMT

PLAQUETTES POSITIVES 5° (À TROU)



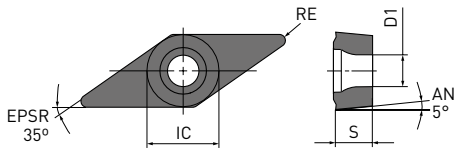

Classe M

VBMT

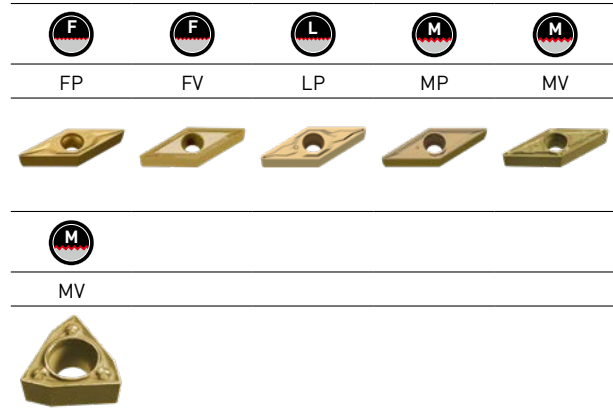
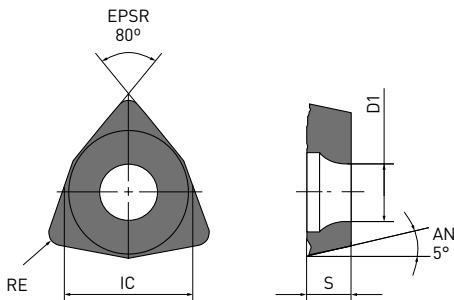

WBMT



Référence	 		MC6115	MC6125	IC	S	RE	D1
	 							
VBMT110302-FP	F		●	●	6.35	3.18	0.2	2.9
VBMT110304-FP	F		●	●	6.35	3.18	0.4	2.9
VBMT110308-FP	F		●	★	6.35	3.18	0.8	2.9
VBMT160404-FP	F		●	●	9.525	4.76	0.4	4.4
VBMT160408-FP	F		●	●	9.525	4.76	0.8	4.4
VBMT110304-FV	F			●	6.35	3.18	0.4	2.9
VBMT110308-FV	F			●	6.35	3.18	0.8	2.9
VBMT160404-FV	F			●	9.525	4.76	0.4	4.4
VBMT160408-FV	F			●	9.525	4.76	0.8	4.4
VBMT110304-LP	L		●	●	6.35	3.18	0.4	2.9
VBMT110308-LP	L		●	●	6.35	3.18	0.8	2.9
VBMT160404-LP	L		●	●	9.525	4.76	0.4	4.4
VBMT160408-LP	L		●	●	9.525	4.76	0.8	4.4
VBMT160404-MP	M		●	●	9.525	4.76	0.4	4.4
VBMT160408-MP	M		●	●	9.525	4.76	0.8	4.4
VBMT110304-MV	M			●	6.35	3.18	0.4	2.9
VBMT110308-MV	M			●	6.35	3.18	0.8	2.9
VBMT160404-MV	M			●	9.525	4.76	0.4	4.4
VBMT160408-MV	M			★	9.525	4.76	0.8	4.4
WBMTL30202L-MV	M			★	4.76	2.38	0.2	2.3
WBMTL30202R-MV	M			●	4.76	2.38	0.2	2.3
WBMTL30204L-MV	M			★	4.76	2.38	0.4	2.3
WBMTL30204R-MV	M			★	4.76	2.38	0.4	2.3

(Conditionnement par quantité 10)





CCMT

PLAQUETTES POSITIVES 7° (À TROU)

Classe M

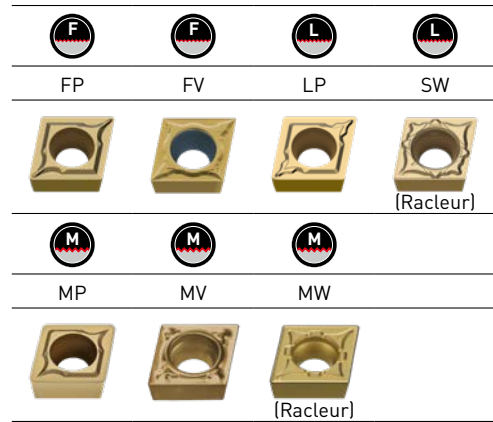
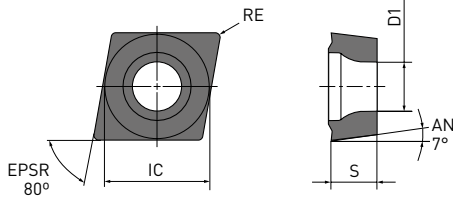
CCMT



Référence			MC6115	MC6125	IC	S	RE	D1
								
CCMT060202-FP	F		●	●	6.35	2.38	0.2	2.8
CCMT060204-FP	F		●	●	6.35	2.38	0.4	2.8
CCMT09T302-FP	F		●	●	9.525	3.97	0.2	4.4
CCMT09T304-FP	F		●	●	9.525	3.97	0.4	4.4
CCMT09T308-FP	F		●	●	9.525	3.97	0.8	4.4
CCMT060202-FV	F			●	6.35	2.38	0.2	2.8
CCMT060204-FV	F			●	6.35	2.38	0.4	2.8
CCMT09T302-FV	F			●	9.525	3.97	0.2	4.4
CCMT09T304-FV	F			●	9.525	3.97	0.4	4.4
CCMT09T308-FV	F			●	9.525	3.97	0.8	4.4
CCMT060202-LP	L			●	6.35	2.38	0.2	2.8
CCMT060204-LP	L		●	●	6.35	2.38	0.4	2.8
CCMT060208-LP	L		●	●	6.35	2.38	0.8	2.8
CCMT09T304-LP	L		●	●	9.525	3.97	0.4	4.4
CCMT09T308-LP	L		●	●	9.525	3.97	0.8	4.4
CCMT060202-SW	L		●	●	6.35	2.38	0.2	2.8
CCMT060204-SW	L		●	●	6.35	2.38	0.4	2.8
CCMT09T302-SW	L		●	●	9.525	3.97	0.2	4.4
CCMT09T304-SW	L		●	●	9.525	3.97	0.4	4.4

[Conditionnement par quantité 10]



CCMT -PLAQUETTES POSITIVES 7° (À TROU)

Référence			MC6115	MC6125	IC	S	RE	D1
	M	R						
CCMT060202-MP	M		●	●	6.35	2.38	0.2	2.8
CCMT060204-MP	M		●	●	6.35	2.38	0.4	2.8
CCMT060208-MP	M		●	●	6.35	2.38	0.8	2.8
CCMT080302-MP	M		★	★	7.94	3.18	0.2	3.4
CCMT080304-MP	M		●	★	7.94	3.18	0.4	3.4
CCMT080308-MP	M		●	★	7.94	3.18	0.8	3.4
CCMT09T302-MP	M		●	●	9.525	3.97	0.2	4.4
CCMT09T304-MP	M		●	●	9.525	3.97	0.4	4.4
CCMT09T308-MP	M		●	●	9.525	3.97	0.8	4.4
CCMT120404-MP	M		●	●	12.7	4.76	0.4	5.5
CCMT120408-MP	M		●	●	12.7	4.76	0.8	5.5
CCMT120412-MP	M		●	●	12.7	4.76	1.2	5.5
CCMH060202-MV	M			●	6.35	2.38	0.2	2.8
CCMH060204-MV	M			●	6.35	2.38	0.4	2.8
CCMT060204-MW	M		●	●	6.35	2.38	0.4	2.8
CCMT060208-MW	M		●	●	6.35	2.38	0.8	2.8
CCMT09T304-MW	M		●	●	9.525	3.97	0.4	4.4
CCMT09T308-MW	M		●	●	9.525	3.97	0.8	4.4
CCMT120404-MW	M		●	●	12.7	4.76	0.4	5.5
CCMT120408-MW	M		●	●	12.7	4.76	0.8	5.5

[Conditionnement par quantité 10]



DCMT

PLAQUETTES POSITIVES 7° (À TROU)

Classe M

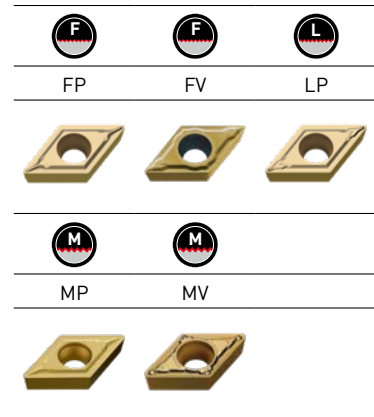
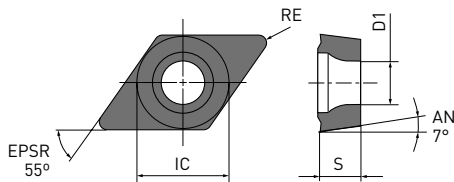
DCMT



Référence	 		MC6115	MC6125	IC	S	RE	D1
	F	L						
DCMT070202-FP	F		●	●	6.35	2.38	0.2	2.8
DCMT070204-FP	F		●	●	6.35	2.38	0.4	2.8
DCMT11T302-FP	F		●	●	9.525	3.97	0.2	4.4
DCMT11T304-FP	F		●	●	9.525	3.97	0.4	4.4
DCMT11T308-FP	F		●	●	9.525	3.97	0.8	4.4
DCMT070202-FV	F		●	●	6.35	2.38	0.2	2.8
DCMT070204-FV	F		●	●	6.35	2.38	0.4	2.8
DCMT070208-FV	F		●	●	6.35	2.38	0.8	2.8
DCMT11T302-FV	F		●	●	9.525	3.97	0.2	4.4
DCMT11T304-FV	F		●	●	9.525	3.97	0.4	4.4
DCMT11T308-FV	F		●	●	9.525	3.97	0.8	4.4
DCMT070202-LP		L		●	6.35	2.38	0.2	2.8
DCMT070204-LP		L	●	●	6.35	2.38	0.4	2.8
DCMT070208-LP		L	●	●	6.35	2.38	0.8	2.8
DCMT11T302-LP		L	●	●	9.525	3.97	0.2	4.4
DCMT11T304-LP		L	●	●	9.525	3.97	0.4	4.4
DCMT11T308-LP		L	●	●	9.525	3.97	0.8	4.4
DCMT070202-MP	M		●	●	6.35	2.38	0.2	2.8
DCMT070204-MP	M		●	●	6.35	2.38	0.4	2.8
DCMT070208-MP	M		●	●	6.35	2.38	0.8	2.8
DCMT11T302-MP	M		●	●	9.525	3.97	0.2	4.4
DCMT11T304-MP	M		●	●	9.525	3.97	0.4	4.4
DCMT11T308-MP	M		●	●	9.525	3.97	0.8	4.4
DCMT11T312-MP	M		●	●	9.525	3.97	1.2	4.4
DCMT150404-MP	M		●	●	12.7	4.76	0.4	5.5
DCMT150408-MP	M		●	●	12.7	4.76	0.8	5.5
DCMT150412-MP	M		●	●	12.7	4.76	1.2	5.5
DCMT070202-MV	M		●	●	6.35	2.38	0.2	2.8
DCMT070204-MV	M		●	●	6.35	2.38	0.4	2.8
DCMT070208-MV	M		●	●	6.35	2.38	0.8	2.8
DCMT11T302-MV	M		●	●	9.525	3.97	0.2	4.4
DCMT11T304-MV	M		●	●	9.525	3.97	0.4	4.4
DCMT11T308-MV	M		●	★	9.525	3.97	0.8	4.4

[Conditionnement par quantité 10]



RCMT, RCMX, SCMT

PLAQUETTES POSITIVES 7° (À TROU)

Classe M

RCMT, RCMX

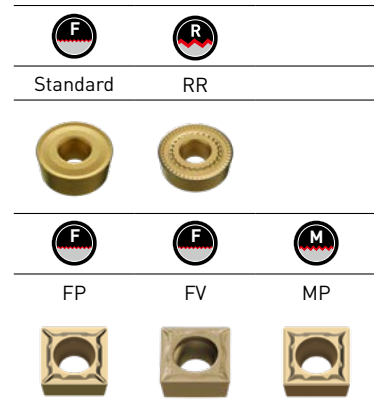
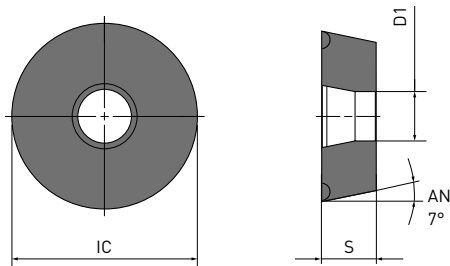

SCMT

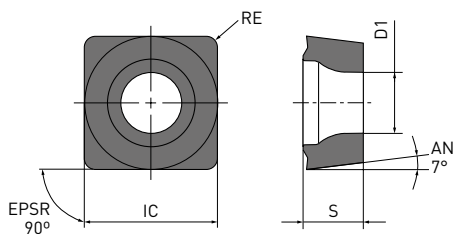

Référence		MC6115	MC6125	IC	S	RE	D1
RCMT0602M0	M	●	●	6	2.38	—	2.8
RCMT0803M0	M	●	●	8	3.18	—	3.4
RCMX1003M0	M	●	●	10	3.18	—	3.6
RCMX1204M0	M	★	●	12	4.76	—	4.2
RCMX1606M0	M	★	●	16	6.35	—	5.2
RCMX2006M0	M	●	●	20	6.35	—	6.5
RCMX1606M0-RR	R	★	●	16	6.35	—	5.2
RCMX2006M0-RR	R	●	★	20	6.35	—	6.5
SCMT09T304-FP	F	●	●	9.525	3.97	0.4	4.4
SCMT09T308-FP	F	●	●	9.525	3.97	0.8	4.4
SCMT09T304-FV	F	●	●	9.525	3.97	0.4	4.4
SCMT09T304-LP	L	●	●	9.525	3.97	0.4	4.4
SCMT09T308-LP	L	●	●	9.525	3.97	0.8	4.4
SCMT09T304-MP	M	●	●	9.525	3.97	0.4	4.4
SCMT09T308-MP	M	●	●	9.525	3.97	0.8	4.4
SCMT120404-MP	M	●	●	12.7	4.76	0.4	5.5
SCMT120408-MP	M	●	●	12.7	4.76	0.8	5.5
SCMT120412-MP	M	●	★	12.7	4.76	1.2	5.5

[Conditionnement par quantité 10]





TCMT

PLAQUETTES POSITIVES 7° (À TROU)

Classe M

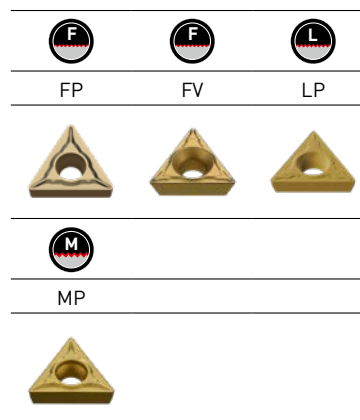
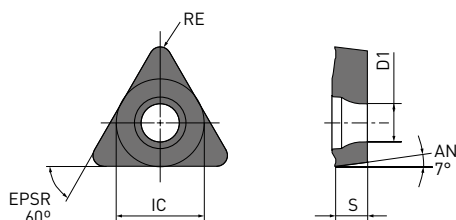
TCMT



Référence			MC6115	MC6125	IC	S	RE	D1
								
TCMT090202-FP	F		●	★	5.56	2.38	0.2	2.5
TCMT090204-FP	F		●	●	5.56	2.38	0.4	2.5
TCMT110202-FP	F		●	★	6.35	2.38	0.2	2.8
TCMT110204-FP	F		●	●	6.35	2.38	0.4	2.8
TCMT16T304-FP	F		●	●	9.525	3.97	0.4	4.4
TCMT110204-FV	F			●	6.35	2.38	0.4	2.8
TCMT16T304-FV	F			●	9.525	3.97	0.4	4.4
TCMT090204-LP	L		●	●	5.56	2.38	0.4	2.5
TCMT090208-LP	L		●	★	5.56	2.38	0.8	2.5
TCMT110204-LP	L		●	●	6.35	2.38	0.4	2.8
TCMT110208-LP	L		●	●	6.35	2.38	0.8	2.8
TCMT16T304-LP	L		●	●	9.525	3.97	0.4	4.4
TCMT16T308-LP	L		●	●	9.525	3.97	0.8	4.4
TCMT090204-MP	M		●	★	5.56	2.38	0.4	2.5
TCMT090208-MP	M		●	★	5.56	2.38	0.8	2.5
TCMT110202-MP	M		●	●	6.35	2.38	0.2	2.8
TCMT110204-MP	M		●	★	6.35	2.38	0.4	2.8
TCMT110208-MP	M		●	★	6.35	2.38	0.8	2.8
TCMT130304-MP	M		●	●	7.94	3.18	0.4	3.4
TCMT16T304-MP	M		●	●	9.525	3.97	0.4	4.4
TCMT16T308-MP	M		●	●	9.525	3.97	0.8	4.4
TCMT16T312-MP	M		●	●	9.525	3.97	1.2	4.4

[Conditionnement par quantité 10]



VCMT, WCMT, XCMT

PLAQUETTES POSITIVES 7° (À TROU)

Classe M

VCMT

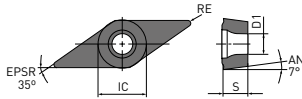

WCMT

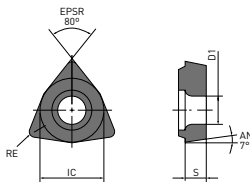

XCMT

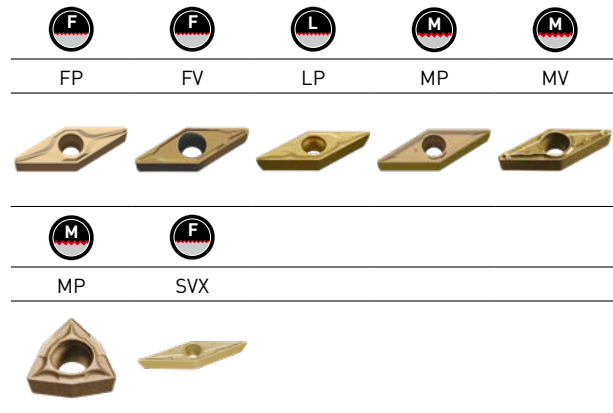
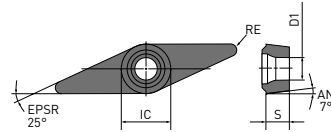

Référence			MC6115	MC6125	IC	S	RE	D1
VCMT110302-FP	F		●	●	6.35	3.18	0.2	2.8
VCMT110304-FP	F		●	●	6.35	3.18	0.4	2.8
VCMT160404-FP	F		●	●	9.525	4.76	0.4	4.4
VCMT160408-FP	F		●	●	9.525	4.76	0.8	4.4
VCMT080202-FV	F			●	4.76	2.38	0.2	2.4
VCMT080204-FV	F			●	4.76	2.38	0.4	2.4
VCMT160404-FV	F		●	●	9.525	4.76	0.4	4.4
VCMT160408-FV	F		●	●	9.525	4.76	0.8	4.4
VCMT080202-LP	L			★	4.76	2.38	0.2	2.4
VCMT080204-LP	L			●	4.76	2.38	0.4	2.4
VCMT110304-LP	L		●	●	6.35	3.18	0.4	2.8
VCMT110308-LP	L		●	●	6.35	3.18	0.8	2.8
VCMT160404-LP	L		●	●	9.525	4.76	0.4	4.4
VCMT160408-LP	L		●	●	9.525	4.76	0.8	4.4
VCMT110304-MP	M		●	●	6.35	3.18	0.4	2.8
VCMT160404-MP	M		●	●	9.525	4.76	0.4	4.4
VCMT160408-MP	M		●	●	9.525	4.76	0.8	4.4
VCMT160412-MP	M		●	★	9.525	4.76	1.2	4.4
VCMT080202-MV	M			★	4.76	2.38	0.2	2.4
VCMT080204-MV	M			●	4.76	2.38	0.4	2.4
WCMT020102-MP	M		★	★	3.97	1.59	0.2	2.3
WCMT020104-MP	M		★	★	3.97	1.59	0.4	2.3
WCMT040202-MP	M		★	★	6.35	2.38	0.2	2.8
WCMT040204-MP	M		★	★	6.35	2.38	0.4	2.8
WCMT040208-MP	M			★	6.35	2.38	0.8	2.8
WCMT06T304-MP	M		★	★	9.525	3.97	0.4	4.4
WCMT06T308-MP	M		★	★	9.525	3.97	0.8	4.4
WCMTL30202-MP	M		★	★	4.76	2.38	0.2	2.3
WCMTL30204-MP	M		★	★	4.76	2.38	0.4	2.3
XCMT150304-SVX	F			●	6.35	3.18	0.4	2.8
XCMT150308-SVX	F			●	6.35	3.18	0.8	2.8

[Conditionnement par quantité 10]







CPMH

PLAQUETTES POSITIVES 11° (À TROU)

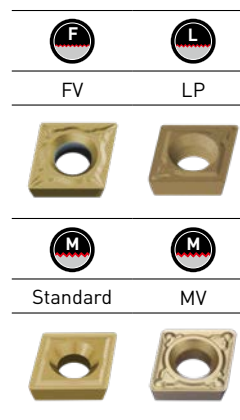
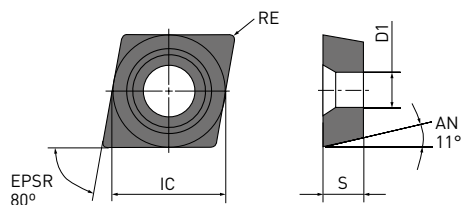
Classe M

CPMH



Référence	   		MC6115	MC6125	IC	S	RE	D1
	F	L						
CPMH080202-FV	F			★	7.94	2.38	0.2	3.5
CPMH080204-FV	F			●	7.94	2.38	0.4	3.5
CPMH090302-FV	F			★	9.525	3.18	0.2	4.5
CPMH090304-FV	F			●	9.525	3.18	0.4	4.5
CPMH090308-FV	F			●	9.525	3.18	0.8	4.5
CPMH080202-LP		L		●	7.94	2.38	0.2	3.5
CPMH080204-LP		L		●	7.94	2.38	0.4	3.5
CPMH090302-LP		L		●	9.525	3.18	0.2	4.5
CPMH090304-LP		L		★	9.525	3.18	0.4	4.5
CPMH090308-LP		L		★	9.525	3.18	0.8	4.5
CPMH080204			M	★	7.94	2.38	0.4	3.5
CPMH080208			M	★	7.94	2.38	0.8	3.5
CPMH090304			M	★	9.525	3.18	0.4	4.5
CPMH090308			M	★	9.525	3.18	0.8	4.5
CPMH080204-MV			M	●	7.94	2.38	0.4	3.5
CPMH080208-MV			M	●	7.94	2.38	0.8	3.5
CPMH090304-MV			M	●	9.525	3.18	0.4	4.5
CPMH090308-MV			M	●	9.525	3.18	0.8	4.5

[Conditionnement par quantité 10]



TPMH

PLAQUETTES POSITIVES 11° (À TROU)

Classe M

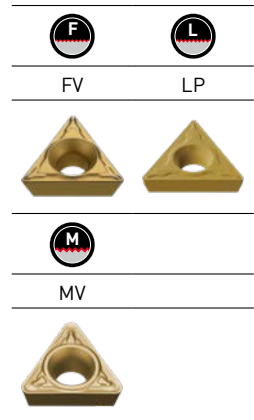
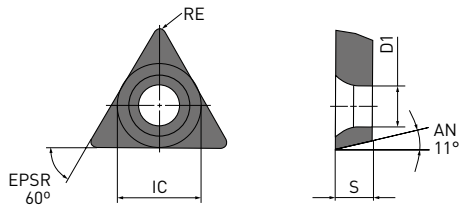
TPMH



Référence	 		MC6115	MC6125	IC	S	RE	D1
TPMH080202-FV	F			★	4.76	2.38	0.2	2.4
TPMH080204-FV	F			★	4.76	2.38	0.4	2.4
TPMH090202-FV	F			★	5.56	2.38	0.2	2.9
TPMH090204-FV	F			●	5.56	2.38	0.4	2.9
TPMH110302-FV	F			★	6.35	3.18	0.2	3.4
TPMH110304-FV	F			●	6.35	3.18	0.4	3.4
TPMH110308-FV	F			●	6.35	3.18	0.8	3.4
TPMH160302-FV	F			●	9.525	3.18	0.2	4.4
TPMH160304-FV	F			★	9.525	3.18	0.4	4.4
TPMH160308-FV	F			●	9.525	3.18	0.8	4.4
TPMH080202-LP		L		●	4.76	2.38	0.2	2.4
TPMH080204-LP		L		●	4.76	2.38	0.4	2.4
TPMH090202-LP		L		★	5.56	2.38	0.2	2.9
TPMH090204-LP		L		●	5.56	2.38	0.4	2.9
TPMH110302-LP		L		★	6.35	3.18	0.2	3.4
TPMH110304-LP		L		●	6.35	3.18	0.4	3.4
TPMH110308-LP		L		★	6.35	3.18	0.8	3.4
TPMH160302-LP		L		★	9.525	3.18	0.2	4.4
TPMH160304-LP		L		★	9.525	3.18	0.4	4.4
TPMH160308-LP		L		★	9.525	3.18	0.8	4.4
TPMH080202-MV			M	●	4.76	2.38	0.2	2.4
TPMH080204-MV			M	●	4.76	2.38	0.4	2.4
TPMH090202-MV			M	●	5.56	2.38	0.2	2.9
TPMH090204-MV			M	●	5.56	2.38	0.4	2.9
TPMH090208-MV			M	●	5.56	2.38	0.8	2.9
TPMH110302-MV			M	●	6.35	3.18	0.2	3.4
TPMH110304-MV			M	●	6.35	3.18	0.4	3.4
TPMH110308-MV			M	●	6.35	3.18	0.8	3.4
TPMH160304-MV			M	●	9.525	3.18	0.4	4.4
TPMH160308-MV			M	★	9.525	3.18	0.8	4.4

[Conditionnement par quantité 10]



WPMT

PLAQUETTES POSITIVES 11° (À TROU)



Classe M

WPMT

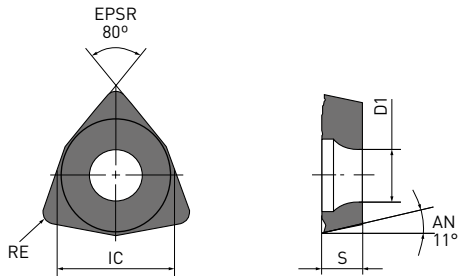

MV



Référence			MC6115	MC6125	IC	S	RE	D1
								
WPMT040202-MV	M			●	6.35	2.38	0.2	2.8
WPMT040204-MV	M			★	6.35	2.38	0.4	2.8
WPMT060304-MV	M			★	9.525	3.18	0.4	4.4
WPMT060308-MV	M			●	9.525	3.18	0.8	4.4

[Conditionnement par quantité 10]



SPMR, SPMN, TPMR, TPMN

PLAQUETTES POSITIVES 11° (SANS TROU)

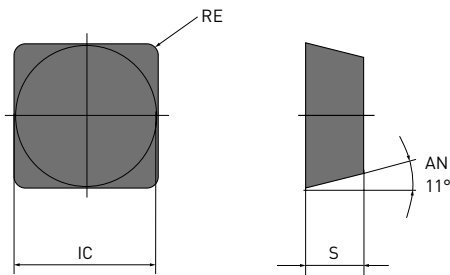

Classe M

SPMR, SPMN

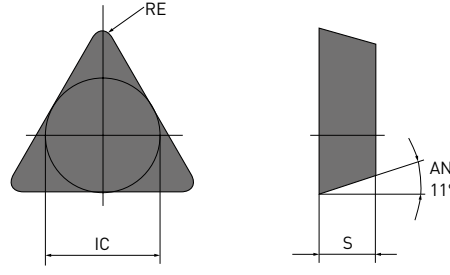

TPMR, TPMN



Référence	 	MC6115	MC6125	IC	S	RE	D1
SPMR090304	L	★	★	9.525	3.18	0.4	-
SPMR090308	L	●	★	9.525	3.18	0.8	-
SPMR120304	L	●	★	12.7	3.18	0.4	-
SPMR120308	L	●	★	12.7	3.18	0.8	-
SPMN090308	—	★		9.525	3.18	0.8	-
SPMN120304	—	★		12.7	3.18	0.4	-
SPMN120308	—	●		12.7	3.18	0.8	-
SPMN120312	—	●		12.7	3.18	1.2	-
TPMR110304	L	●	★	6.35	3.18	0.4	-
TPMR110308	L	●	★	6.35	3.18	0.8	-
TPMR160304	L	●	★	9.525	3.18	0.4	-
TPMR160308	L	●	★	9.525	3.18	0.8	-
TPMR160312	L	●	★	9.525	3.18	1.2	-
TPMN110304	—	●		6.35	3.18	0.4	-
TPMN110308	—	★		6.35	3.18	0.8	-
TPMN160304	—	●		9.525	3.18	0.4	-
TPMN160308	—	●		9.525	3.18	0.8	-
TPMN160312	—	★		9.525	3.18	1.2	-
TPMN220404	—	★		12.7	4.76	0.4	-
TPMN220408	—	★		12.7	4.76	0.8	-
TPMN220412	—	★		12.7	4.76	1.2	-



[Conditionnement par quantité 10]



SÉRIE MC6100

CONDITIONS DE COUPE RECOMMANDÉES

PLAQUETTES POSITIVES 5° ET 7° (TOURNAGE EXTERNE)

Matière	Dureté	Conditions		Nuance		Vc	f	ap
								
Acier doux	≤180HB	●	F	MC6115	FP	295-570	0.04-0.20	0.20-0.90
		●	F	MC6115	FV	295-570	0.04-0.20	0.20-0.90
		●	L	MC6115	LP	295-570	0.06-0.25	0.20-1.00
		●	L	MC6115	SW	295-570	0.06-0.24	0.20-1.50
		●	M	MC6115	MP	245-475	0.08-0.30	0.30-2.00
		●	M	MC6115	MV	245-475	0.08-0.30	0.30-2.00
		●	M	MC6115	MW	245-475	0.10-0.35	0.80-2.50
		⊕	F	MC6125	FP	320-505	0.04-0.20	0.20-0.90
		⊕	F	MC6125	FV	320-505	0.04-0.20	0.20-0.90
		⊕	L	MC6125	LP	320-505	0.06-0.25	0.20-1.00
		⊕	L	MC6125	SV	320-505	0.06-0.25	0.20-1.00
		⊕	L	MC6125	SW	320-505	0.06-0.24	0.20-1.50
		⊕	M	MC6125	MP	270-420	0.08-0.30	0.30-2.00
		⊕	M	MC6125	MV	270-420	0.08-0.30	0.30-2.00
		⊕	M	MC6125	MW	270-420	0.10-0.35	0.80-2.50
		P Aciers carbone et alliés	180-280HB	●	F	MC6115	FP	220-420
●	F			MC6115	FV	220-420	0.04-0.20	0.20-0.90
●	L			MC6115	LP	220-420	0.06-0.25	0.20-1.00
●	L			MC6115	SW	220-420	0.06-0.24	0.20-1.50
●	M			MC6125	MP	200-310	0.08-0.30	0.30-2.00
●	M			MC6115	MP	180-350	0.08-0.30	0.30-2.00
●	M			MC6125	MV	200-310	0.08-0.30	0.30-2.00
●	M			MC6115	MV	180-350	0.08-0.30	0.30-2.00
●	M			MC6115	MW	180-350	0.10-0.35	0.80-2.50
⊕	F			MC6125	FP	240-370	0.04-0.20	0.20-0.90
⊕	F			MC6125	FV	240-370	0.04-0.20	0.20-0.90
⊕	L			MC6125	LP	240-370	0.06-0.25	0.20-1.00
⊕	L			MC6125	SV	240-370	0.06-0.25	0.20-1.00
⊕	L			MC6125	SW	240-370	0.06-0.24	0.20-1.50
⊕	M			MC6125	MP	200-310	0.08-0.30	0.30-2.00
⊕	M			MC6125	MV	200-310	0.08-0.30	0.30-2.00
⊕	M	MC6125	MW	200-310	0.10-0.35	0.80-2.50		
Aciers carbone et alliés	280-350HB	●	F	MC6115	FP	155-295	0.04-0.20	0.20-0.90
		●	F	MC6115	FV	155-295	0.04-0.20	0.20-0.90
		●	L	MC6115	LP	155-295	0.06-0.25	0.20-1.00
		●	M	MC6115	MP	130-245	0.08-0.30	0.30-2.00
		●	M	MC6115	MV	130-245	0.08-0.30	0.30-2.00
		⊕	F	MC6125	FP	170-265	0.04-0.20	0.20-0.90
		⊕	F	MC6125	FV	170-265	0.04-0.20	0.20-0.90
		⊕	L	MC6125	LP	170-265	0.06-0.25	0.20-1.00
		⊕	M	MC6125	MP	140-220	0.08-0.30	0.30-2.00
		⊕	M	MC6125	MV	140-220	0.08-0.30	0.30-2.00

SÉRIE MC6100

CONDITIONS DE COUPE RECOMMANDÉES

PLAQUETTES POSITIVES 11° (TOURNAGE EXTERNE)

Matière	Dureté	Conditions	Nuance	Vc	f	ap
Acier doux	≤180HB	● F	MC6125 FV	320-505	0.04-0.20	0.20-0.90
		● L	MC6125 LP	320-505	0.06-0.25	0.20-1.00
		● L	MC6115 R-Std	245-475	0.08-0.30	0.30-2.00
		● M	MC6125 MV	270-420	0.08-0.30	0.30-2.00
		● M	MC6115 MV	245-475	0.08-0.30	0.30-2.00
		● M	MC6125 R-Std	270-420	0.08-0.30	0.30-2.00
		✚ L	MC6125 LP	320-505	0.06-0.25	0.20-1.00
		✚ L	MC6125 R-Std	270-420	0.08-0.30	0.30-2.00
		✚ M	MC6125 MV	270-420	0.08-0.30	0.30-2.00
		✚ M	MC6125 R-Std	270-420	0.08-0.30	0.30-2.00
Aciers carbone et alliés	180-280HB	● F	MC6125 FV	240-370	0.04-0.20	0.20-0.90
		● L	MC6125 LP	240-370	0.06-0.25	0.20-1.00
		● L	MC6115 R-Std	180-350	0.08-0.30	0.30-2.00
		● L	MC6125 R-Std	200-310	0.08-0.30	0.30-2.00
		● M	MC6125 MV	200-310	0.08-0.30	0.30-2.00
		● M	MC6115 R-Std	180-350	0.08-0.30	0.30-2.00
		● M	MC6125 R-Std	200-310	0.08-0.30	0.30-2.00
		✚ L	MC6125 LP	240-370	0.06-0.25	0.20-1.00
		✚ L	MC6125 R-Std	200-310	0.08-0.30	0.30-2.00
		✚ M	MC6125 MV	200-310	0.08-0.30	0.30-2.00
✚ M	MC6125 R-Std	200-310	0.08-0.30	0.30-2.00		

- Les conditions de coupe recommandées pour les plaquettes positives 5°/7°/11° sont fournies uniquement à titre indicatif. Vérifiez les conditions de coupe pour chaque opération d'alésage car les conditions de coupe en l'usinage intérieur varient en fonction du porte-à-faux.
- Veillez utiliser le code QR ci-contre pour les conditions de coupe de la plaquette de copiage XCMT.



SÉRIE GY

GRAND CHOIX DE PORTE-OUTILS ET PLAQUETTES POUR
DIVERSES APPLICATIONS D'USINAGE DE GORGE



NEW



En savoir plus...

B140

www.mhg-mediastore.net

DIA  **EDGE**

SÉRIE GY

GRAND CHOIX DE PLAQUETTES

TRONÇONNAGE



Brise-copeaux GU (Pour l'acier mou) Brise-copeaux GS (Avances faibles) Brise-copeaux GM (Avances moyennes) Brise-copeaux R/L05-GM (Avances moyennes) Brise-copeaux R08-GS (Avances faibles) Brise-copeaux R15-GS (Avances faibles) Brise-Copeaux GL (Pour alliages d'aluminium)

GORGE



Brise-copeaux GU (Pour l'acier mou) Brise-copeaux GS (Avances faibles) Brise-copeaux GM (Avances moyennes) GFGS (Pour matières traitées et trempées) Brise-Copeaux GL (Pour alliages d'aluminium)

GORGES MULTI-DIRECTIONNELLES



Brise-copeaux MF (Finition) Brise-copeaux MS (Avances faibles) Brise-copeaux MM (Avances moyennes)

COPIAGE / PIQUAGE



Brise-copeaux BM (Avances moyennes)

Brise-copeaux	RT9010	RT9020	VP10RT	VP20RT	MY6015	NX2525	BC8110	MP9015	MP9025
Brise-copeaux GU			✓	✓		✓			
Brise-copeaux GS	✓	✓	✓	✓		✓			
Brise-copeaux GM			✓	✓	✓	✓		✓	✓
Brise-Copeaux GL	✓								
Brise-copeaux MF	✓		✓	✓		✓			
Brise-copeaux MS			✓	✓	✓	✓			
Brise-copeaux MM			✓	✓	✓	✓		✓	✓
Brise-copeaux BM			✓	✓	✓	✓		✓	✓
Ébauche de plaquette	✓	✓				✓			
Sans Brise-copeaux (PCBN)							✓		

SÉRIE GY

GRAND CHOIX DE PORTE-OUTILS ET PLAQUETTES DISPONIBLES POUR DIVERSES APPLICATIONS D'USINAGE DE GORGE

EXTERIEUR • PORTE-OUTILS FRONTAUX

Porte-outils monobloc et à cartouche

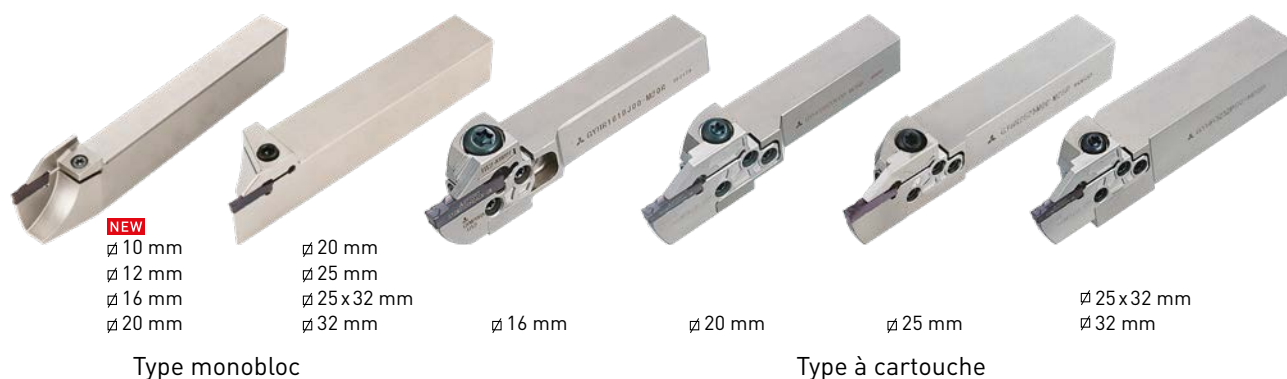

Différentes profondeurs de gorge sont possibles avec un seul outil utilisant différents cartouches.

Différentes tailles de gorges frontales avec une large gamme de cartouches.

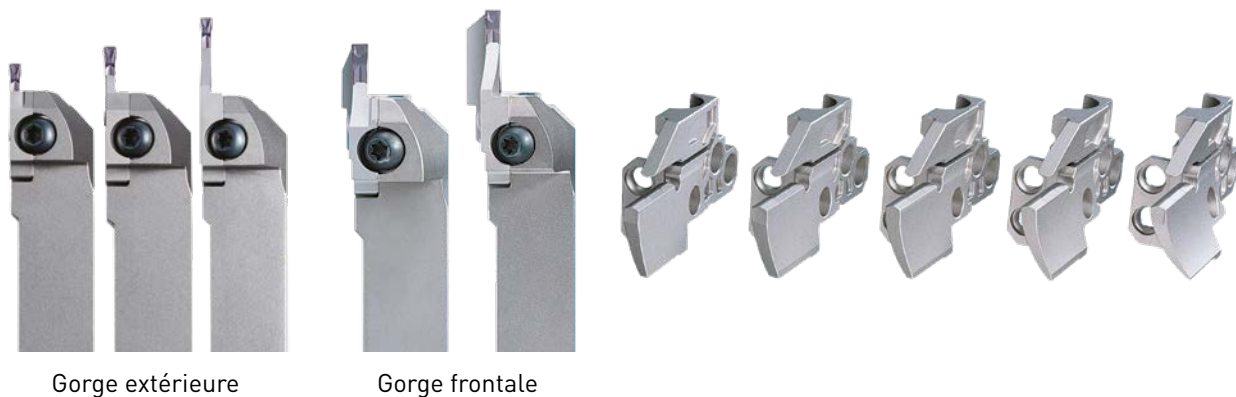

BARRES POUR GORGES INTERNES

Grand choix de porte-outils disponibles, à partir d'un diamètre minimum de Ø25 mm.

Séries courtes en standard catalogue.



SÉRIE GY

OUTILS MONOBLOC POUR GORGES EXTERNES

Porte-outil monobloc
∅ 20 mm × 20 mm
∅ 25 mm × 25 mm

Logement de plaquette renforcé

Serrage par vis

2 arêtes

Largeur de coupe 2.0–8.0 mm

Outils de décolletage

SÉRIE GY

LE SERRAGE DE PLAQUETTE RENFORCÉ ASSURE LA FIABILITÉ EN DÉCOLLETAGE

GRANDE RAIDEUR DE BRIDAGE

Les clavettes bloquent la plaquette dans sa position.

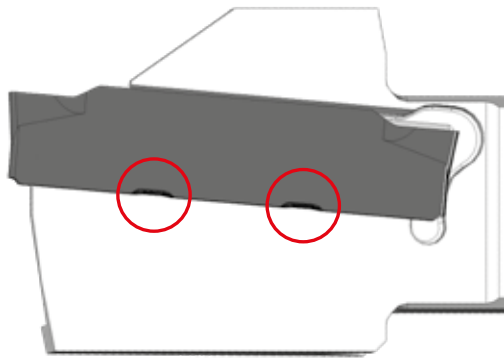

Le contact convexe assure une grande précision de positionnement.

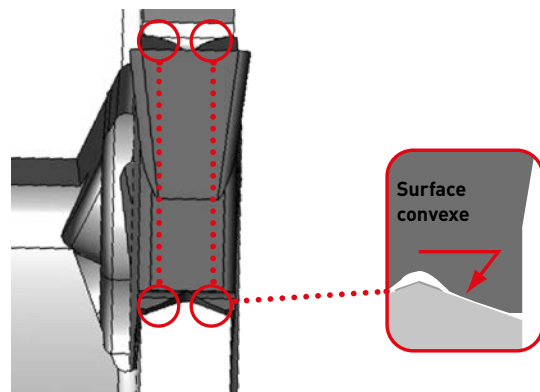

OUTILS MONOBLOC POUR LE DÉCOLLETAGE

Les porte-outils de grande raideur suppriment les vibrations et assurent une bonne tenue de cote.

LONGUEUR DE SORTIE ADAPTÉE AUX TOURS DE DÉCOLLETAGE

Les longueurs de sortie sont adaptées aux diamètres de pièces maximaux des tours de décolletage.

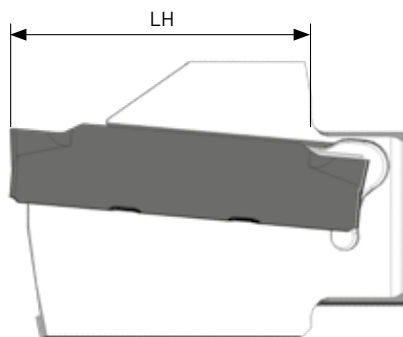

SÉRIE GY

CARACTÉRISTIQUES DES OUTILS DE DÉCOLLETAGE

BRIDE RENFORCÉE

La grande raideur de la bride renforcée supprime les vibrations.

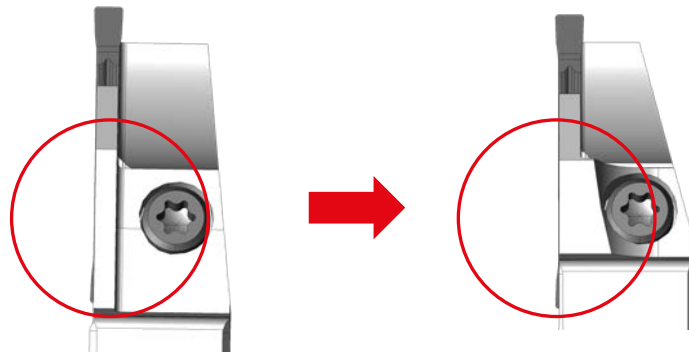

BASE RENFORCÉE

Le déflexion due aux efforts de coupe est largement réduite.

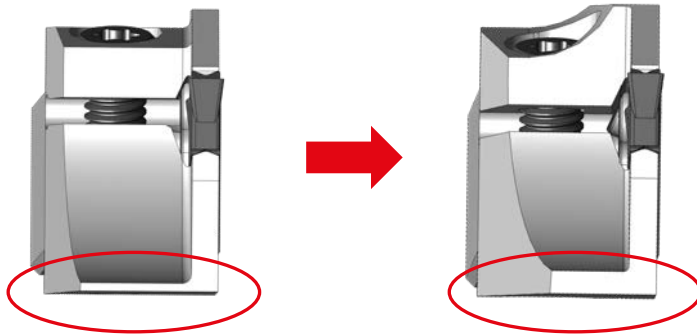

Déflexion d'outil : 0.044 mm

Déflexion d'outil : 0.013 mm

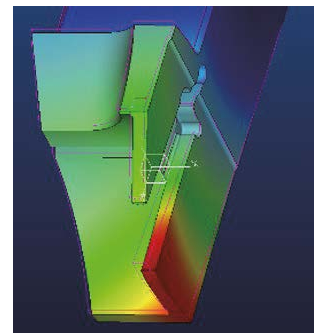

Simulation numérique de la déformation

SURFACE D'ASSISE AUGMENTÉE

L'augmentation de la surface d'appui de la plaquette participe à la raideur d'outil

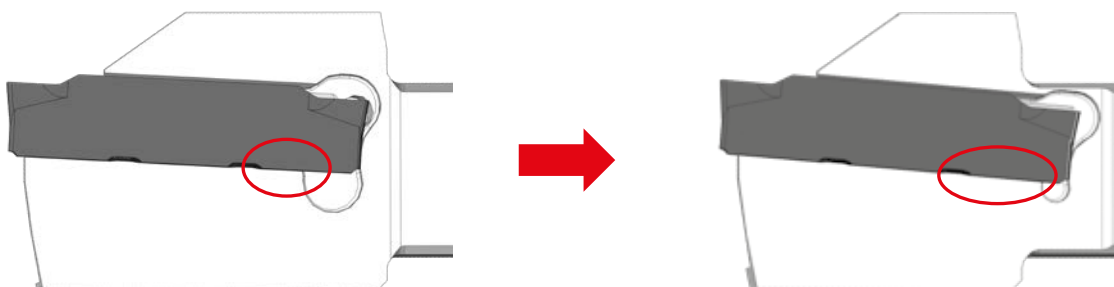

SÉRIE GY

EXTENSION DE GAMME PLAQUETTES

BRISE-COPEAUX POUR FAIBLES EFFORTS DE COUPE / FAIBLES AVANCES

Plaquette GS à 8° et 15°

La précision de dressage est améliorée, le téton central est réduit, un bon état de surface est assuré.

PERFORMANCES D'USINAGE

Tronçonnage d'inox 304

Tronçonnage complet



GY
Brise-Copeaux GS



Téton central $\emptyset 0.49$ mm, Rz 9 μm

Tronçonnage incomplet



Conventionnel A



Téton central $\emptyset 0.58$ mm, Rz 43 μm

Tronçonnage incomplet

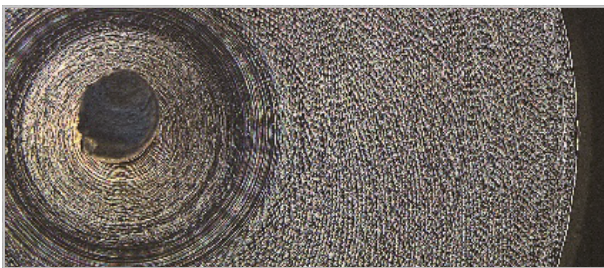

Conventionnel B



Téton central $\emptyset 1.42$ mm, Rz 15 μm

Matière	Inox 304 $\emptyset 16$ mm
Outil	CW = 2 mm Inclinaison 15°
Vc (m/min)	100
fz (mm/tr)	0.03
Arrosage	Huile soluble

SÉRIE GY

PERFORMANCES EN DÉCOLLETAGE

COMPARATIF DE LA DÉFLEXION D'OUTIL

La grande raideur d'outil réduit les vibrations, ce qui améliore l'état de surface obtenu. La taille du téton central est également réduite.

Raideur d'outil

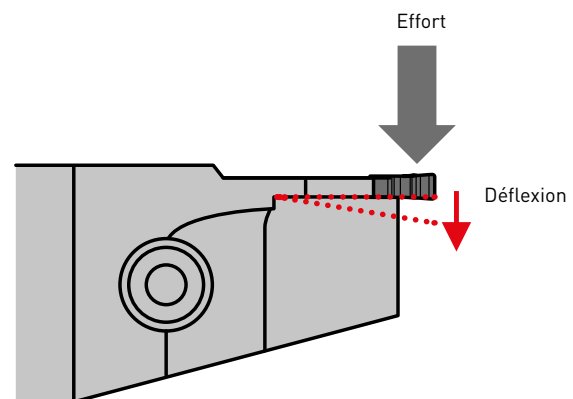
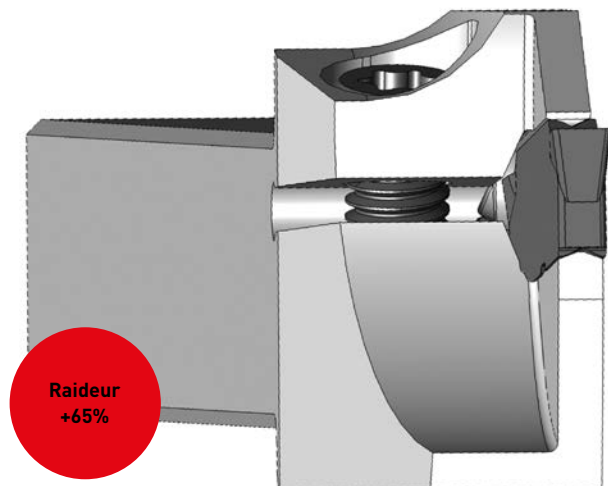
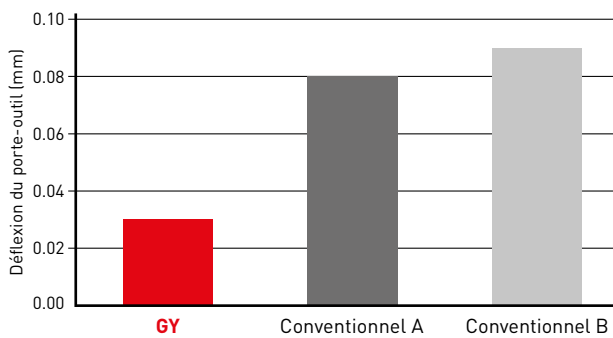

SÉRIE GY

PERFORMANCES EN DÉCOLLETAGE

COMPARATIF DE L'ÉTAT DE SURFACE EN TRONÇONNAGE (INOX 304)

Le porte-outil de grande raideur réduit les vibrations et la déflexion d'outil, ce qui améliore grandement l'état de surface.

Visuel de l'état de surface

Rz 1.8 µm

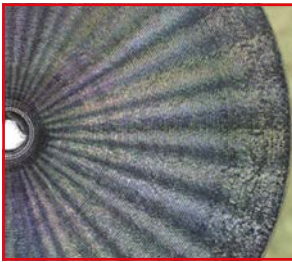

GY

Rz 5.6 µm

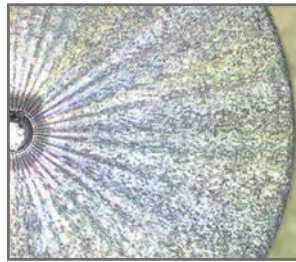

Conventiennel A

Rz 4.1 µm

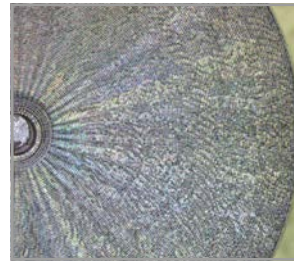

Conventiennel B

Rz 5.7 µm

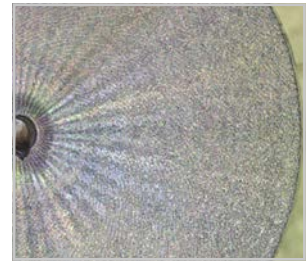

Conventiennel C

Matière	Inox 304 Ø25 mm
Outil	CW = 2 mm RE = 0.2 mm 16 x 16
Vc (m/min)	120
fz (mm/tr)	0.10
Arrosage	Huile soluble



SÉRIE GY

PERFORMANCES EN DÉCOLLETAGE

COMPARATIF DE PRÉCISION DE DRESSAGE (INOX 304)

Visuel du défaut de forme



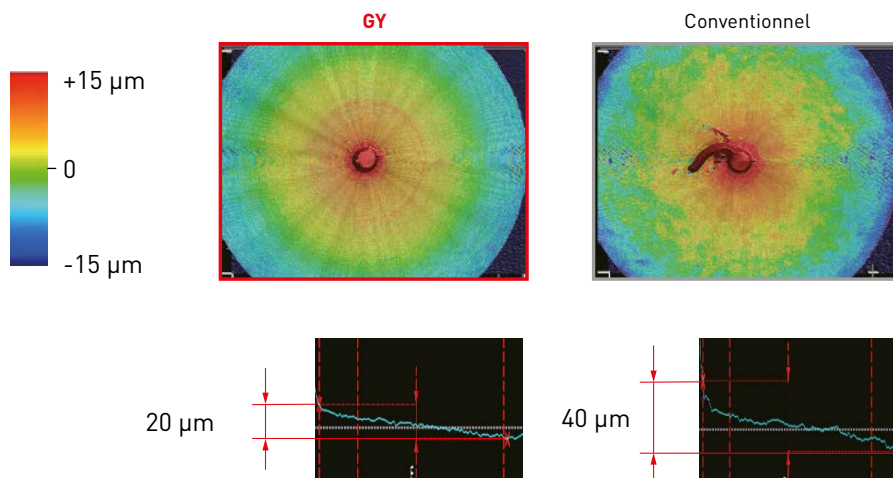

Écart de hauteur

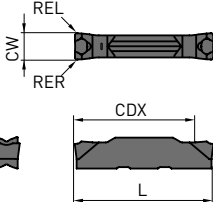

1/2 des produits conventionnels

Matière	Inox 304 Ø25 mm
Outil	CW = 2 mm RE = 0.2 mm 16 x 16
Vc (m/min)	120
fz (mm/tr)	0.10
Arrosage	Huile soluble

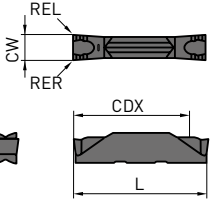
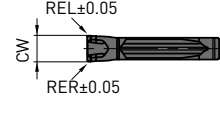
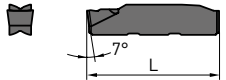
PLAQUETTES

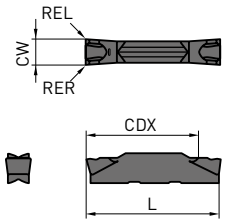
Référence	RT9010	RT9020	VP10RT	VP20RT	MY5015	NX2525	BC8110	MP9015	MP9025	Dimension de l'assise	CW	Tolérance	RE R/L	CDX	L	Géométrie
GORGE / TRONÇONNAGE																
GY2M0200D020N-GU			●	●	●					D	2.00	±0.03	0.2	19.7	20.70	Brise-copeaux GU (Pour l'acier mou)  
GY2M0239E020N-GU			●	●	●					E	2.39	±0.03	0.2	19.8	20.70	
GY2M0250E020N-GU			●	●	●					E	2.50	±0.03	0.2	19.5	20.70	
GY2M0300F030N-GU			●	●	●					F	3.00	±0.03	0.3	19.3	20.70	
GY2M0318F030N-GU			●	●	●					F	3.18	±0.03	0.3	19.3	20.70	
GY2M0400G030N-GU			●	●	●					G	4.00	±0.04	0.3	24.2	25.65	
GY2M0475H040N-GU			●	●	●					H	4.75	±0.04	0.4	24.2	25.65	
GY2M0500H040N-GU			●	●	●					H	5.00	±0.04	0.4	24.2	25.65	
GY2M0600J040N-GU			●	●	●					J	6.00	±0.04	0.4	24.2	25.65	
GY2M0635J040N-GU			●	●	●					J	6.35	±0.04	0.4	24.2	25.65	
GY2M0120B010N-GS			●	●						B	1.20	±0.03	0.1	12.2	14.70	Brise-copeaux GS (Avances faibles)  
GY2M0150C010N-GS			●	●						C	1.50	±0.03	0.1	13.4	14.70	
GY2M0200D020N-GS			●	●	●					D	2.00	±0.03	0.2	18.7	20.70	
GY2M0239E020N-GS			●	●	●					E	2.39	±0.03	0.2	18.5	20.70	
GY2M0250E020N-GS			●	●	●					E	2.50	±0.03	0.2	18.5	20.70	
GY2M0300F020N-GS			●	●	●					F	3.00	±0.03	0.2	18.5	20.70	
GY2M0318F020N-GS			●	●	●					F	3.18	±0.03	0.2	18.5	20.70	
GY2M0400G020N-GS			●	●	●					G	4.00	±0.04	0.2	23.9	25.65	
GY2M0475H030N-GS			●	●	●					H	4.75	±0.04	0.3	23.9	25.65	
GY2M0500H030N-GS			●	●	●					H	5.00	±0.04	0.3	24.0	25.65	
GY2M0600J030N-GS			●	●	●					J	6.00	±0.04	0.3	24.1	25.65	
GY2M0635J030N-GS			●	●	●					J	6.35	±0.04	0.3	24.1	25.65	
GY2M0800K030N-GS			●	●						K	8.00	±0.04	0.3	29.1	30.50	
GY1M0200D020N-GM			●	●	●		●	●		D	2.00	±0.03	0.2	-	20.70	Brise-copeaux GM (Avances moyennes)  
GY1M0250E020N-GM			●	●	★		●	●		E	2.50	±0.03	0.2	-	20.70	
GY1M0300F030N-GM			●	●	●		●	●		F	3.00	±0.03	0.3	-	20.70	
GY1M0400G030N-GM			●	●	●		●	●		G	4.00	±0.04	0.3	-	25.65	
GY1M0500H040N-GM			●	●	●		●	●		H	5.00	±0.04	0.4	-	25.65	
GY2M0150C020N-GM			●	●	●		●	●		C	1.50	±0.03	0.2	13.9	14.70	Brise-copeaux GM (Avances moyennes)  
GY2M0200D020N-GM			●	●	●		●	●		D	2.00	±0.03	0.2	19.4	20.70	
GY2M0239E020N-GM			●	●	●		●	●		E	2.39	±0.03	0.2	19.4	20.70	
GY2M0250E020N-GM			●	●	●		●	●		E	2.50	±0.03	0.2	19.4	20.70	
GY2M0300F030N-GM			●	●	●		●	●		F	3.00	±0.03	0.3	19.4	20.70	
GY2M0318F030N-GM			●	●	●		●	●		F	3.18	±0.03	0.3	19.4	20.70	
GY2M0400G030N-GM			●	●	●		●	●		G	4.00	±0.04	0.3	24.4	25.65	
GY2M0475H040N-GM			●	●	●		●	●		H	4.75	±0.04	0.4	24.3	25.65	
GY2M0500H040N-GM			●	●	●		●	●		H	5.00	±0.04	0.4	24.3	25.65	
GY2M0600J040N-GM			●	●	●		●	●		J	6.00	±0.04	0.4	24.3	25.65	
GY2M0635J040N-GM			●	●	●		●	●		J	6.35	±0.04	0.4	24.3	25.65	
GY2M0800K050N-GM			●	●	●		●	●		K	8.00	±0.04	0.5	29.3	30.50	

PLAQUETTES



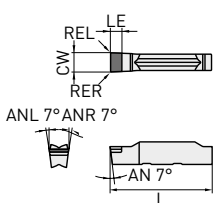
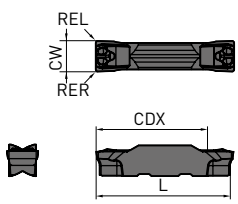
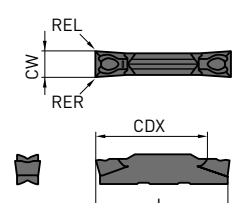

Référence	RT9010	RT9020	VP10RT	VP20RT	MY5015	NX2525	BC8110	MP9015	MP9025	Dimension de l'assise	CW	Tolérance	RE R/L	CDX	L	Géométrie
GORGE / TRONÇONNAGE																
GY2G0200D005N-GL	●									D	2.00	±0.02	0.05	19.5	21.05	Brise-Copeaux GL (Pour alliages d'aluminium)
GY2G0250E005N-GL	●									E	2.50	±0.02	0.05	19.1	21.05	
GY2G0300F005N-GL	●									F	3.00	±0.02	0.05	18.9	21.05	
TRONÇONNAGE																
GY1M0200D020R05-GM	●	●								D	2.00	±0.03	0.2	-	20.80	Brise-copeaux R/L05-GM
GY1M0200D020L05-GM	★	●								D	2.00	±0.03	0.2	-	20.80	
GY1M0300F030R05-GM	●	●								F	3.00	±0.03	0.3	-	20.85	
GY1M0300F030L05-GM	●	●								F	3.00	±0.03	0.3	-	20.85	
<i>Plaque vue à gauche.</i>																
GY2M0200D020R05-GM	●	●								D	2.00	±0.03	0.2	19.5	20.80	Brise-copeaux R/L05-GM
GY2M0200D020L05-GM	●	●								D	2.00	±0.03	0.2	19.5	20.80	
GY2M0250E020R05-GM	●	●								E	2.50	±0.03	0.2	19.5	20.825	
GY2M0250E020L05-GM	●	●								E	2.50	±0.03	0.2	19.5	20.825	
GY2M0300F030R05-GM	●	●								F	3.00	±0.03	0.3	19.5	20.85	
GY2M0300F030L05-GM	●	●								F	3.00	±0.03	0.3	19.5	20.85	
GY2M0400G030R05-GM	●	●								G	4.00	±0.04	0.3	24.5	25.85	
GY2M0400G030L05-GM	●	●								G	4.00	±0.04	0.3	24.5	25.85	
GY2M0500H040R05-GM	●	●								H	5.00	±0.04	0.4	24.5	25.95	
GY2M0500H040L05-GM	●	●								H	5.00	±0.04	0.4	24.5	25.95	<i>Plaque représentée à droite.</i>
GY2M0120B010R05-GS	★	★								B	1.20	±0.03	0.1	12.22	14.70	Brise-copeaux R/L05-GS (Avances faibles)
<i>Plaque vue à gauche.</i>																
GY2G0150C010R08-GS	●	●								C	1.50	±0.02	0.1	13.17	15.20	Brise-copeaux R08-GS (Avances faibles)
GY2G0200D020R08-GS	●	●								D	2.00	±0.03	0.2	18.85	21.30	
GY2G0250E020R08-GS	●	●								E	2.50	±0.03	0.2	19.04	21.50	
GY2G0300F020R08-GS	●	●								F	3.00	±0.03	0.2	18.62	21.50	
<i>Plaque vue à gauche.</i>																
GY2G0150C003R15-GS	●	●								C	1.50	±0.02	0.03	13.17	15.20	Brise-copeaux R15-GS (Avances faibles)
GY2G0150C010R15-GS	●	●								C	1.50	±0.02	0.1	13.17	15.20	
GY2G0200D003R15-GS	●	●								D	2.00	±0.03	0.03	18.85	21.30	
GY2G0200D010R15-GS	●	●								D	2.00	±0.03	0.1	18.85	21.30	
GY2G0250E003R15-GS	●	●								E	2.50	±0.03	0.03	19.04	21.50	
GY2G0250E020R15-GS	●	●								E	2.50	±0.03	0.2	19.04	21.50	
GY2G0300F003R15-GS	●	●								F	3.00	±0.03	0.03	18.62	21.50	
GY2G0300F020R15-GS	●	●								F	3.00	±0.03	0.2	18.62	21.50	

PLAQUETTES

Référence	RT9010	RT9020	VP10RT	VP20RT	MY5015	NX2525	BC8110	MP9015	MP9025	Dimension de l'assise	CW	Tolérance	RE R/L	CDX	L	LE	Géométrie
GORGE																	
GY1G0200D020N-GFGS							●			D	2.00	±0.03	0.2	—	20.70	2.7	(Pour matières traitées et trempées) 
GY1G0239E020N-GFGS							●			E	2.39	±0.03	0.2	—	20.70	2.7	
GY1G0250E020N-GFGS							●			E	2.50	±0.03	0.2	—	20.70	2.7	
GY1G0300F020N-GFGS							●			F	3.00	±0.03	0.2	—	20.70	2.7	
GY1G0318F020N-GFGS							●			F	3.18	±0.03	0.2	—	20.70	2.7	
GY1G0400G020N-GFGS							●			G	4.00	±0.03	0.2	—	25.65	2.7	
GY1G0475H020N-GFGS							●			H	4.75	±0.03	0.2	—	25.65	2.7	
GY1G0500H020N-GFGS							●			H	5.00	±0.03	0.2	—	25.65	2.7	
GY1G0600J020N-GFGS							●			J	6.00	±0.03	0.2	—	25.65	2.7	
GORGES MULTI-DIRECTIONNELLES																	
GY2G0200D020N-MF	●	●	●	●						D	2.00	±0.02	0.2	19.5	21.05	—	Brise-copeaux MF (Finition) 
GY2G0224D015N-MF*1	●	●	●	●						D	2.24	±0.02	0.15	19.8	21.05	—	
GY2G0239E020N-MF	★	★	★	★						E	2.39	±0.02	0.2	19.2	21.05	—	
GY2G0250E020N-MF	●	●	●	●						E	2.50	±0.02	0.2	19.4	21.05	—	
GY2G0274E020N-MF*1	●	●	●	●						E	2.74	±0.02	0.2	19.7	21.05	—	
GY2G0300F020N-MF	●	●	●	●						F	3.00	±0.02	0.2	19.5	21.05	—	
GY2G0300F040N-MF	●	●	●	●						F	3.00	±0.02	0.4	19.3	21.05	—	
GY2G0318F020N-MF	★	★	★	★						F	3.18	±0.02	0.2	19.5	21.05	—	
GY2G0318F040N-MF	★	★	★	★						F	3.18	±0.02	0.4	19.3	21.05	—	
GY2G0324F020N-MF*1	●	●	●	●						F	3.24	±0.02	0.2	19.5	21.05	—	
GY2G0400G020N-MF	●	●	●	●						G	4.00	±0.02	0.2	24.9	25.95	—	
GY2G0400G040N-MF	●	●	●	●						G	4.00	±0.02	0.4	24.7	25.95	—	
GY2G0400G080N-MF	●	●	●	●						G	4.00	±0.02	0.8	24.3	25.95	—	
GY2G0424G020N-MF*1	●	●	●	●						G	4.24	±0.02	0.2	24.9	25.95	—	
GY2G0475H020N-MF	★	★	★	★						H	4.75	±0.02	0.2	24.4	25.95	—	
GY2G0475H040N-MF	★	★	★	★						H	4.75	±0.02	0.4	24.2	25.95	—	
GY2G0475H080N-MF	★	★	★	★						H	4.75	±0.02	0.8	23.8	25.95	—	
GY2G0500H020N-MF	●	●	●	●						H	5.00	±0.02	0.2	24.4	25.95	—	
GY2G0500H040N-MF	●	●	●	●						H	5.00	±0.02	0.4	24.2	25.95	—	
GY2G0500H080N-MF	●	●	●	●						H	5.00	±0.02	0.8	23.8	25.95	—	
GY2G0524H020N-MF*1	●	●	●	●						H	5.24	±0.02	0.2	24.4	25.95	—	
GY2G0600J020N-MF	●	●	●	●						J	6.00	±0.02	0.2	24.4	25.95	—	
GY2G0600J040N-MF	●	●	●	●						J	6.00	±0.02	0.4	24.2	25.95	—	
GY2G0600J080N-MF	●	●	●	●						J	6.00	±0.02	0.8	23.8	25.95	—	
GY2G0631J020N-MF*1	●	●	●	●						J	6.31	±0.02	0.2	24.4	25.95	—	
GY2G0635J020N-MF	★	★	★	★						J	6.35	±0.02	0.2	24.4	25.95	—	
GY2G0635J040N-MF	★	★	★	★						J	6.35	±0.02	0.4	24.2	25.95	—	
GY2G0635J080N-MF	★	★	★	★						J	6.35	±0.02	0.8	23.8	25.95	—	
GY2M0200D020N-MS		●	●	●	●					D	2.00	±0.03	0.2	19.1	20.70	—	Brise-copeaux MS (Avances faibles) 
GY2M0250E020N-MS		●	●	●	●					E	2.50	±0.03	0.2	19.1	20.70	—	
GY2M0300F020N-MS		●	●	●	●					F	3.00	±0.03	0.2	19.2	20.70	—	
GY2M0300F040N-MS		●	●	●	●					F	3.00	±0.03	0.4	18.9	20.70	—	
GY2M0400G020N-MS		●	●	●	●					G	4.00	±0.04	0.2	24.2	25.65	—	
GY2M0400G040N-MS		●	●	●	●					G	4.00	±0.04	0.4	23.9	25.65	—	
GY2M0500H040N-MS		●	●	●	●					H	5.00	±0.04	0.4	23.9	25.65	—	
GY2M0500H080N-MS		●	●	●	●					H	5.00	±0.04	0.8	23.5	25.65	—	
GY2M0600J040N-MS		●	●	●	●					J	6.00	±0.04	0.4	23.9	25.65	—	
GY2M0600J080N-MS		●	●	●	●					J	6.00	±0.04	0.8	23.5	25.65	—	
GY2M0800K080N-MS		●	●	●						K	8.00	±0.04	0.8	28.5	30.50	—	

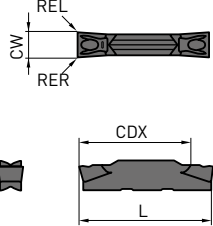
Largeur de gorge type circlip.

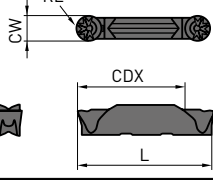
PLAQUETTES

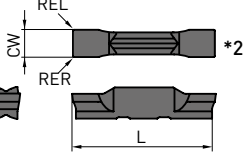
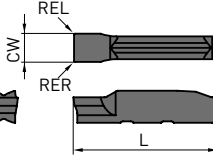
Référence	RT9010	RT9020	VP10RT	VP20RT	MY5015	NX2525	BC8110	MP9015	MP9025	Dimension de l'assise	CW	Tolérance	RE R/L	CDX	L	Géométrie
GORGES MULTI-DIRECTIONNELLES																
GY2M0200D020N-MM	●	●	●	●	●	●	●	●	●	D	2.00	±0.03	0.2	19.1	20.70	Brise-copeaux MM (Avances moyennes)  
GY2M0250E020N-MM	●	●	●	●	●	●	●	●	●	E	2.50	±0.03	0.2	19.1	20.70	
GY2M0300F020N-MM	●	●	●	●	●	●	●	●	●	F	3.00	±0.03	0.2	19.1	20.70	
GY2M0300F040N-MM	●	●	●	●	●	●	●	●	●	F	3.00	±0.03	0.4	18.9	20.70	
GY2M0300F080N-MM	●	●	●	●	●	●	●	●	●	F	3.00	±0.03	0.8	18.5	20.70	
GY2M0400G020N-MM	●	●	●	●	●	●	●	●	●	G	4.00	±0.04	0.2	24.1	25.65	
GY2M0400G040N-MM	●	●	●	●	●	●	●	●	●	G	4.00	±0.04	0.4	23.9	25.65	
GY2M0400G080N-MM	●	●	●	●	●	●	●	●	●	G	4.00	±0.04	0.8	23.5	25.65	
GY2M0500H040N-MM	●	●	●	●	●	●	●	●	●	H	5.00	±0.04	0.4	23.9	25.65	
GY2M0500H080N-MM	●	●	●	●	●	●	●	●	●	H	5.00	±0.04	0.8	23.5	25.65	
GY2M0600J040N-MM	●	●	●	●	●	●	●	●	●	J	6.00	±0.04	0.4	23.9	25.65	
GY2M0600J080N-MM	●	●	●	●	●	●	●	●	●	J	6.00	±0.04	0.8	23.5	25.65	
GY2M0800K080N-MM	●	●	●	●	●	●	●	●	●	K	8.00	±0.04	0.8	28.5	30.50	
GY2M0800K120N-MM	●	●	●	●	●	●	●	●	●	K	8.00	±0.04	1.2	28.1	30.50	
POUR LE COPIAGE / PIQUAGE																
GY2M0200D100N-BM	●	●	●	●	●	●	●	●	●	D	2.00	±0.03	1.00	19.5	20.90	Brise-copeaux BM  
GY2M0250E125N-BM	●	●	●	●	●	●	●	●	●	E	2.50	±0.03	1.25	19.3	20.90	
GY2M0300F150N-BM	●	●	●	●	●	●	●	●	●	F	3.00	±0.03	1.50	19.0	20.90	
GY2M0318F159N-BM	●	●	●	●	●	●	●	●	●	F	3.18	±0.03	1.59	18.9	20.90	
GY2M0400G200N-BM	●	●	●	●	●	●	●	●	●	G	4.00	±0.04	2.00	23.4	25.80	
GY2M0475H238N-BM	●	●	●	●	●	●	●	●	●	H	4.75	±0.04	2.38	22.9	25.80	
GY2M0500H250N-BM	●	●	●	●	●	●	●	●	●	H	5.00	±0.04	2.50	22.8	25.80	
GY2M0600J300N-BM	●	●	●	●	●	●	●	●	●	J	6.00	±0.04	3.00	22.5	25.90	
GY2M0635J318N-BM	●	●	●	●	●	●	●	●	●	J	6.35	±0.04	3.18	22.3	25.90	
GY2M0800K400N-BM	●	●	●	●	●	●	●	●	●	K	8.00	±0.04	4.00	26.5	30.80	
ÉBAUCHES																
GY2B0220D020N	●	●				●				D	2.20	±0.10	0.2	—	21.05	Sans brise-copeaux 
GY2B0250D020N	●	●				●				D	2.55	±0.10	0.2	—	21.28	
GY2B0270E020N	●	●				●				E	2.70	±0.10	0.2	—	21.05	
GY2B0300E020N	●	●				●				E	3.05	±0.10	0.2	—	21.28	
GY2B0340F020N	●	●				●				F	3.40	±0.10	0.2	—	21.05	
GY2B0360F020N	●	●				●				F	3.65	±0.10	0.2	—	21.28	
GY2B0420G020N	●	●				●				G	4.20	±0.10	0.2	—	26.00	
GY2B0460G020N	●	●				●				G	4.65	±0.10	0.2	—	26.18	
GY2B0520H020N	●	●				●				H	5.20	±0.10	0.2	—	26.00	
GY2B0560H020N	●	●				●				H	5.65	±0.10	0.2	—	26.18	
GY2B0655J020N	●	●				●				J	6.55	±0.10	0.2	—	26.00	
GY2B0680J020N	●	●				●				J	6.85	±0.10	0.2	—	26.18	
GY2B0880K020N	●	●				●				K	8.85	±0.10	0.2	—	30.88	
GY1B0220D020N	●	●				●				D	2.20	±0.10	0.2	—	21.07	2 Type d'arête 
GY1B0270E020N	●	●				●				E	2.70	±0.10	0.2	—	21.10	
GY1B0340F020N	●	●				●				F	3.40	±0.10	0.2	—	21.00	
GY1B0420G020N	●	●				●				G	4.20	±0.10	0.2	—	25.86	
GY1B0520H020N	●	●				●				H	5.20	±0.10	0.2	—	25.90	
GY1B0655J020N	●	●				●				J	6.55	±0.10	0.2	—	25.90	
GY1B0880K020N	●	●				●				K	8.85	±0.10	0.2	—	30.88	
1 Type d'arête																
GY1B0220D020N	●	●				●				D	2.20	±0.10	0.2	—	21.07	1 Type d'arête 
GY1B0270E020N	●	●				●				E	2.70	±0.10	0.2	—	21.10	
GY1B0340F020N	●	●				●				F	3.40	±0.10	0.2	—	21.00	
GY1B0420G020N	●	●				●				G	4.20	±0.10	0.2	—	25.86	
GY1B0520H020N	●	●				●				H	5.20	±0.10	0.2	—	25.90	
GY1B0655J020N	●	●				●				J	6.55	±0.10	0.2	—	25.90	
GY1B0880K020N	●	●				●				K	8.85	±0.10	0.2	—	30.88	

*2 Plaquette brutes pour affûtage par le client.

SÉRIE GY

PLAQUETTES POUR LE DÉCOLLETAGE

SÉLECTION DE LA PLAQUETTE

Dimension de l'assise	Référence de plaquette
B	GY00120B0000-(voir brise-copeaux ci-dessous)
C	GY00150C0000-(voir brise-copeaux ci-dessous)
D	GY00200/0224D0000-(voir brise-copeaux ci-dessous)
E	GY00239/0250/0274E0000-(voir brise-copeaux ci-dessous)
F	GY00300/0318/0324F0000-(voir brise-copeaux ci-dessous)

Plaquettes multidirectionnelles

Dimension de l'assise	CW	MF	MS	MM	BM
		(Plaquette rectifiée)	(Avances faibles)	(avances moyennes)	(Copiage)
D	2.00	●	●	●	●
	2.24	●			
	2.39	●			
E	2.50	●	●	●	●
	2.74	●			
F	3.00				●
	RE 0.2	●	●	●	
	RE 0.4	●	●	●	
	RE 0.8			●	
	3.18				●
	RE 0.2	●			
	RE 0.4	●			
3.24	●				

Plaquettes de tronçonnage

Dimension de l'assise	CW	05-GS	08-GS	15-GS	05-GM
		(Avances faibles)	(Avances faibles)	(Avances faibles)	(avances moyennes)
		R	R	R	R/L
B	1.20	★			
C	1.50		●	●	
D	2.00		●	●	
E	2.39		●	●	●
	2.50				
F	3.00		●	●	●
	3.18		●	●	●

Sélection de l'angle d'attaque

Dimension de l'assise	CW	GU	GS	GM	GL	GFGS
		(aciers doux)	(Avances faibles)	(avances moyennes)	(aluminium)	(aciers traités)
		Neutre	Neutre	Neutre	Neutre	Neutre
B	1.20		●			
C	1.50		●	●		
D	2.00	●	●	●	●	●
	2.39	●	●	●		●
E	2.50	●	●	●	●	●
	3.00	●	●	●	●	●
F	3.18	●	●	●		●

SÉLECTION DE L'ANGLE D'ATTAQUE

Première recommandation



SÉRIE GY

DIAMÈTRES DE GORGE AVEC LES OUTILS MONOBLOC

Avec les outils monobloc, la profondeur maximale de gorge dépend du diamètre de la pièce.

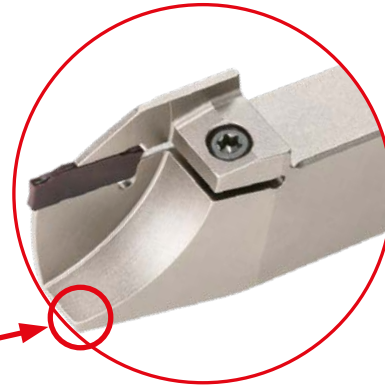
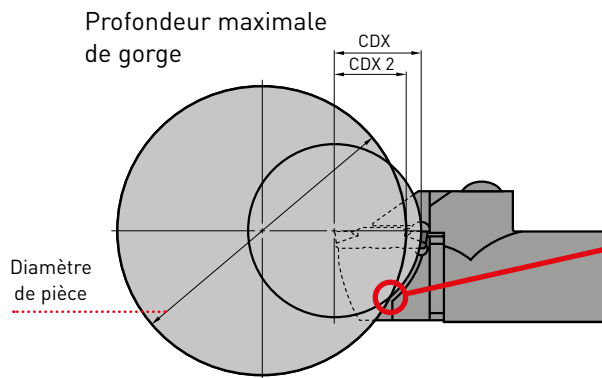

La profondeur de gorge est limitée par l'interférence avec le diamètre externe de la pièce.

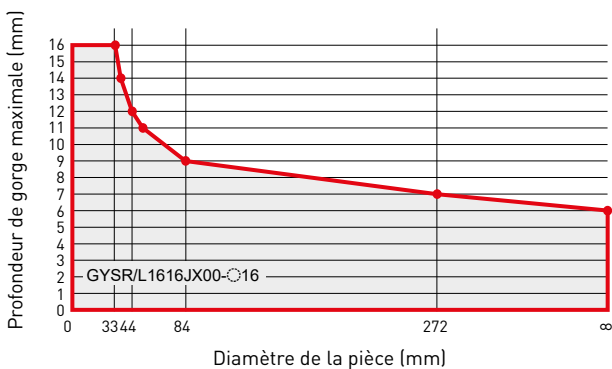
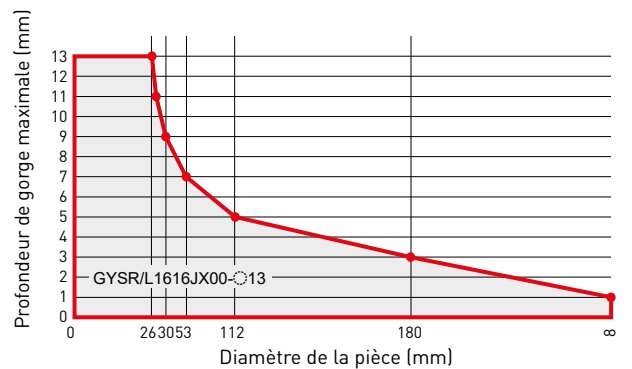
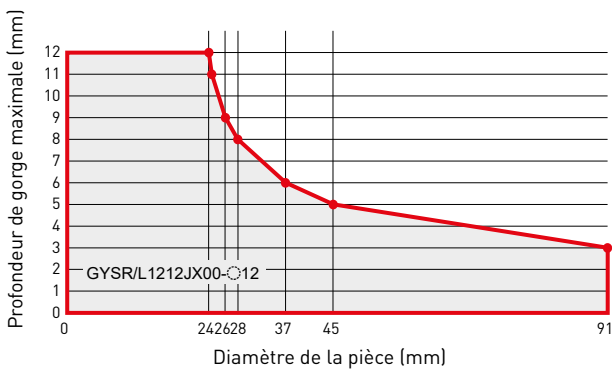
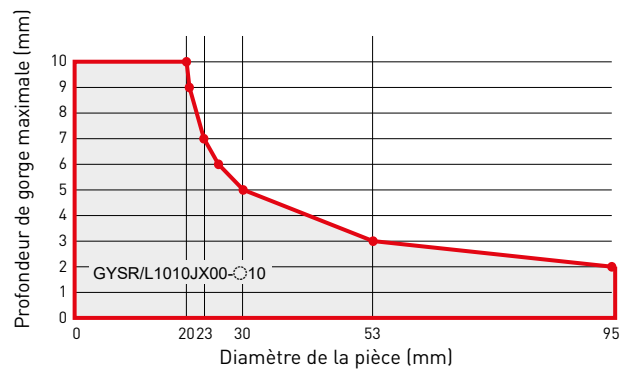
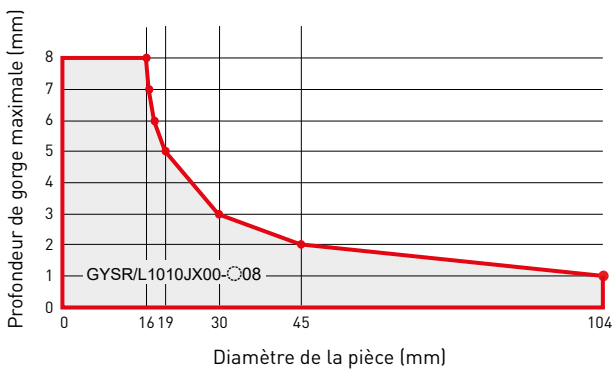

SÉRIE GY

AVANCES EN TRONÇONNAGE

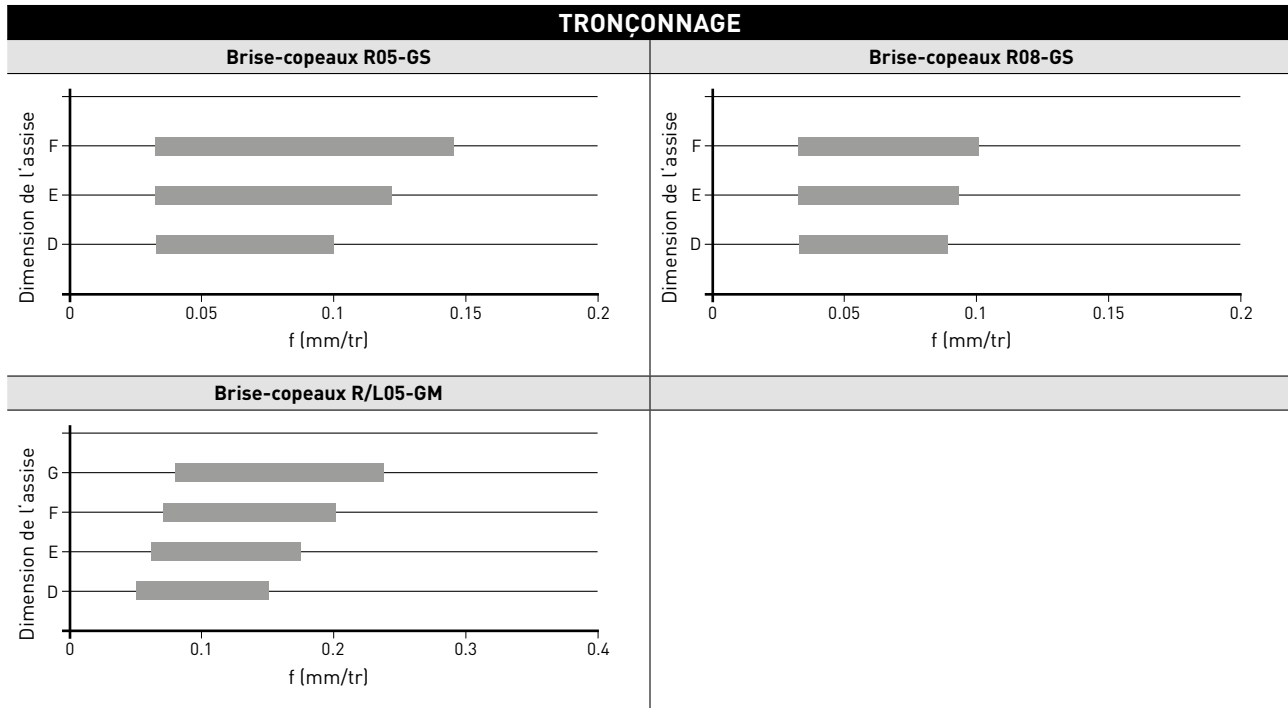

Brise-copeaux	PSIPR	Sens	f (mm/tr)			
			Dimension de l'assise D	Dimension de l'assise E	Dimension de l'assise F	Dimension de l'assise G
R05-GS	5°	R	0.03-0.10	0.03-0.12	0.03-0.14	—
R08-GS	8°	R	0.03-0.08	0.03-0.09	0.03-0.10	—
R05-GM	5°	R/L	0.05-0.15	0.06-0.17	0.07-0.20	0.08-0.23

SÉRIE GY

PORTE-OUTILS DE DÉCOLLETAGE

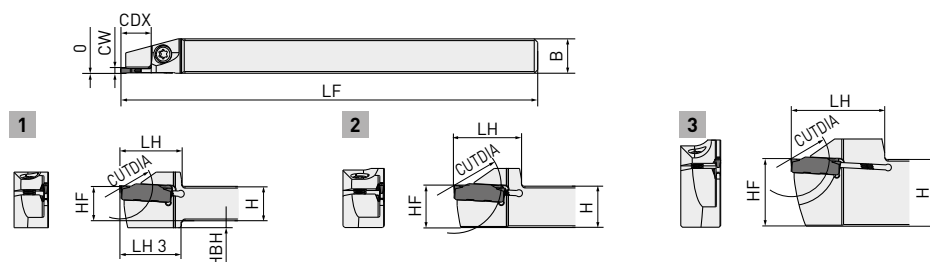

Outil représenté à droite.

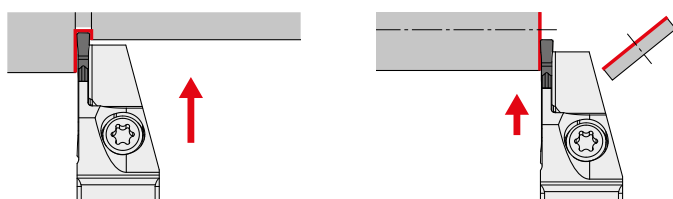

Référence	Dimension de l'assise	CW	CDX*2	CUTDIA	Sens	Stock	H	B	LF	LH	LH3	HF*1	HBH	Fig.		
GYSR1010JX00-B08	B	1.20	8	16	R	●	10	10	120	17.5	17.5	10	2	1		
GYSL1010JX00-B08					L	●	10	10	120	17.5	17.5	10	2	1		
GYSR1212JX00-B08					R	●	12	12	120	19.5	—	12	—	2		
GYSL1212JX00-B08					L	●	12	12	120	19.5	—	12	—	2		
GYSR1212JX00-B12					R	●	12	12	120	19.5	19.5	12	2	1		
GYSL1212JX00-B12					L	●	12	12	120	19.5	19.5	12	2	1		
GYSR1616JX00-B08			R	●	16	16	120	25.0	—	16	—	2				
GYSL1616JX00-B08			L	●	16	16	120	25.0	—	16	—	2				
GYSR1616JX00-B13			R	●	16	16	120	25.0	—	16	—	2				
GYSL1616JX00-B13			L	●	16	16	120	25.0	—	16	—	2				
NEW GYSR1010JX00-C08			C	1.50	8	16	R	●	10	10	120	17.5	17.5	10	2	1
NEW GYSL1010JX00-C08							L	●	10	10	120	17.5	17.5	10	2	1
NEW GYSR1212JX00-C08	R	●					12	12	120	19.5	—	12	—	2		
NEW GYSL1212JX00-C08	L	●					12	12	120	19.5	—	12	—	2		
NEW GYSR1212JX00-C12	R	●					12	12	120	19.5	19.5	12	2	1		
NEW GYSL1212JX00-C12	L	●					12	12	120	19.5	19.5	12	2	1		
NEW GYSR1616JX00-C13	R	●			16	16	120	25.0	—	16	—	2				
NEW GYSL1616JX00-C13	L	●			16	16	120	25.0	—	16	—	2				
NEW GYSR2012JX00-C13	R	★			20	12	120	28.0	—	20	—	3				
NEW GYSL2012JX00-C13	L	★			20	12	120	28.0	—	20	—	3				
NEW GYSR1010JX00-D10	D	2.00			10	20	R	★	10	10	120	17.5	17.5	10	2	1
NEW GYSL1010JX00-D10							L	★	10	10	120	17.5	17.5	10	2	1
NEW GYSR1212JX00-D12			R	●	12	12	120	19.5	19.5	12	2	1				
NEW GYSL1212JX00-D12			L	●	12	12	120	19.5	19.5	12	2	1				
NEW GYSR1616JX00-D13			R	●	16	16	120	25	—	16	—	2				
NEW GYSL1616JX00-D13			L	●	16	16	120	25	—	16	—	2				
NEW GYSR1616JX00-D16			R	★	16	16	120	28	—	16	—	2				
NEW GYSL1616JX00-D16			L	●	16	16	120	28	—	16	—	2				

PORTE-OUTILS DE DÉCOLLETAGE

Référence	Dimension de l'assise	CW	CDX*2	CUTDIA	Sens	Stock	H	B	LF	LH	LH3	HF*1	HBH	Fig.	
NEW GYSR1915K00-D17	D	2.24	17	34	R	★	19.05	15.875	125	28	—	19.05	—	3	
NEW GYSL1915K00-D17					L	★	19.05	15.875	125	28	—	19.05	—	3	
NEW GYSR2012JX00-D17					R	★	20	12	120	28	—	20	—	3	
NEW GYSL2012JX00-D17					L	★	20	12	120	28	—	20	—	3	
NEW GYSR2020K00-D17					R	★	20	20	125	35	—	20	—	2	
NEW GYSL2020K00-D17					L	★	20	20	125	35	—	20	—	2	
NEW GYSR2525M00-D17					R	★	25	25	150	40	—	25	—	2	
NEW GYSL2525M00-D17					L	★	25	25	150	40	—	25	—	2	
NEW GYSR1010JX00-E10	E	2.39	10	20	R	★	10	10	120	17.5	17.5	10	2	1	
NEW GYSL1010JX00-E10					L	★	10	10	120	17.5	17.5	10	2	1	
NEW GYSR1212JX00-E12			12	24	R	★	12	12	120	19.5	19.5	12	2	1	
NEW GYSL1212JX00-E12					L	★	12	12	120	19.5	19.5	12	2	1	
NEW GYSR1616JX00-E13			13	26	R	★	16	16	120	25	—	16	—	2	
NEW GYSL1616JX00-E13					L	★	16	16	120	25	—	16	—	2	
NEW GYSR1616JX00-E16			16	32	R	★	16	16	120	28	—	16	—	2	
NEW GYSL1616JX00-E16					L	★	16	16	120	28	—	16	—	2	
NEW GYSR1915K00-E17			17	34	R	★	19.05	15.875	125	28	—	19.05	—	3	
NEW GYSL1915K00-E17					L	★	19.05	15.875	125	28	—	19.05	—	3	
NEW GYSR2012JX00-E17			2.74	17	34	R	★	20	12	120	28	—	20	—	3
NEW GYSL2012JX00-E17						L	★	20	12	120	28	—	20	—	3
NEW GYSR2020K00-E17						R	★	20	20	125	35	—	20	—	2
NEW GYSL2020K00-E17						L	★	20	20	125	35	—	20	—	2
NEW GYSR2525M00-E17						R	★	25	25	150	40	—	25	—	2
NEW GYSL2525M00-E17						L	★	25	25	150	40	—	25	—	2
NEW GYSR1212JX00-F12	3.00	12	24	R	★	12	12	120	19.5	19.5	12	2	1		
NEW GYSL1212JX00-F12				L	●	12	12	120	19.5	19.5	12	2	1		
NEW GYSR1616JX00-F13		13	26	R	★	16	16	120	25	—	16	—	2		
NEW GYSL1616JX00-F13				L	★	16	16	120	25	—	16	—	2		
NEW GYSR1616JX00-F16	3.18	16	32	R	●	16	16	120	28	—	16	—	2		
NEW GYSL1616JX00-F16				L	★	16	16	120	28	—	16	—	2		
NEW GYSR1915K00-F17	3.24	17	34	R	★	19.05	15.875	125	28	—	19.05	—	3		
NEW GYSL1915K00-F17				L	★	19.05	15.875	125	28	—	19.05	—	3		
NEW GYSR2012JX00-F17				R	★	20	12	120	28	—	20	—	3		
NEW GYSL2012JX00-F17				L	★	20	12	120	28	—	20	—	3		

*1 Les dimensions indiquées sont celles observées lors de l'utilisation de la plaquette calibre. Si d'autres géométries de plaquette sont utilisées, alors les valeurs LF, LH et WF peuvent varier.

*2 La profondeur maximale de tronçonnage est limitée par le diamètre de la pièce.



Outils de DÉCOLLETAGE GY

CONDITIONS DE COUPE RECOMMANDÉES

VITESSES DE COUPE (GORGE EXTERNE ET TRONÇONNAGE)

Matière	Dureté	Nuance	Vc	
P	Acier doux	VP20RT	155 (100-220)	
		VP10RT	170 (110-230)	
		NX2525	150 (90-210)	
	Acier au carbone Acier allié	160-280HB	VP20RT	120 (80-180)
			VP10RT	140 (90-190)
			MY5015	180 (110-250)
		≥280HB	NX2525	120 (70-170)
			VP20RT	100 (60-140)
			VP10RT	110 (70-150)
			MY5015	150 (90-210)
M	Acier inoxydable	NX2525	95 (55-135)	
		VP20RT	100 (60-140)	
K	Fonte grise	VP10RT	110 (70-150)	
		VP20RT	120 (80-180)	
		VP10RT	140 (90-190)	
	Fonte ductile	MY5015	120 (140-300)	
		VP20RT	100 (60-140)	
		VP10RT	110 (70-150)	
N	Alliage d'aluminium (A6061, 7075)	MY5015	150 (90-210)	
		RT9010	250 (200-500)	
		RT9010	250 (200-500)	
S	Alliage d'aluminium (AC4B)	RT9010	150 (100-200)	
		Alliage réfractaire Alliage titane	MP9015	70 (40-100)
			MP9025	60 (30- 90)
VP20RT	45 (30- 60)			
H	Acier traité	VP10RT	55 (40- 70)	
		RT9010	55 (40- 70)	
		BC8110	100 (80-120)	

Pour les VP10RT, VP20RT, MP9015, MP9025 et MY5015, l'usinage avec arrosage est recommandé.

MP / MT9000

PLAQUETTES DE TOURNAGE ISO
POUR LE TOURNAGE DE TITANE ET RÉFRACTAIRES

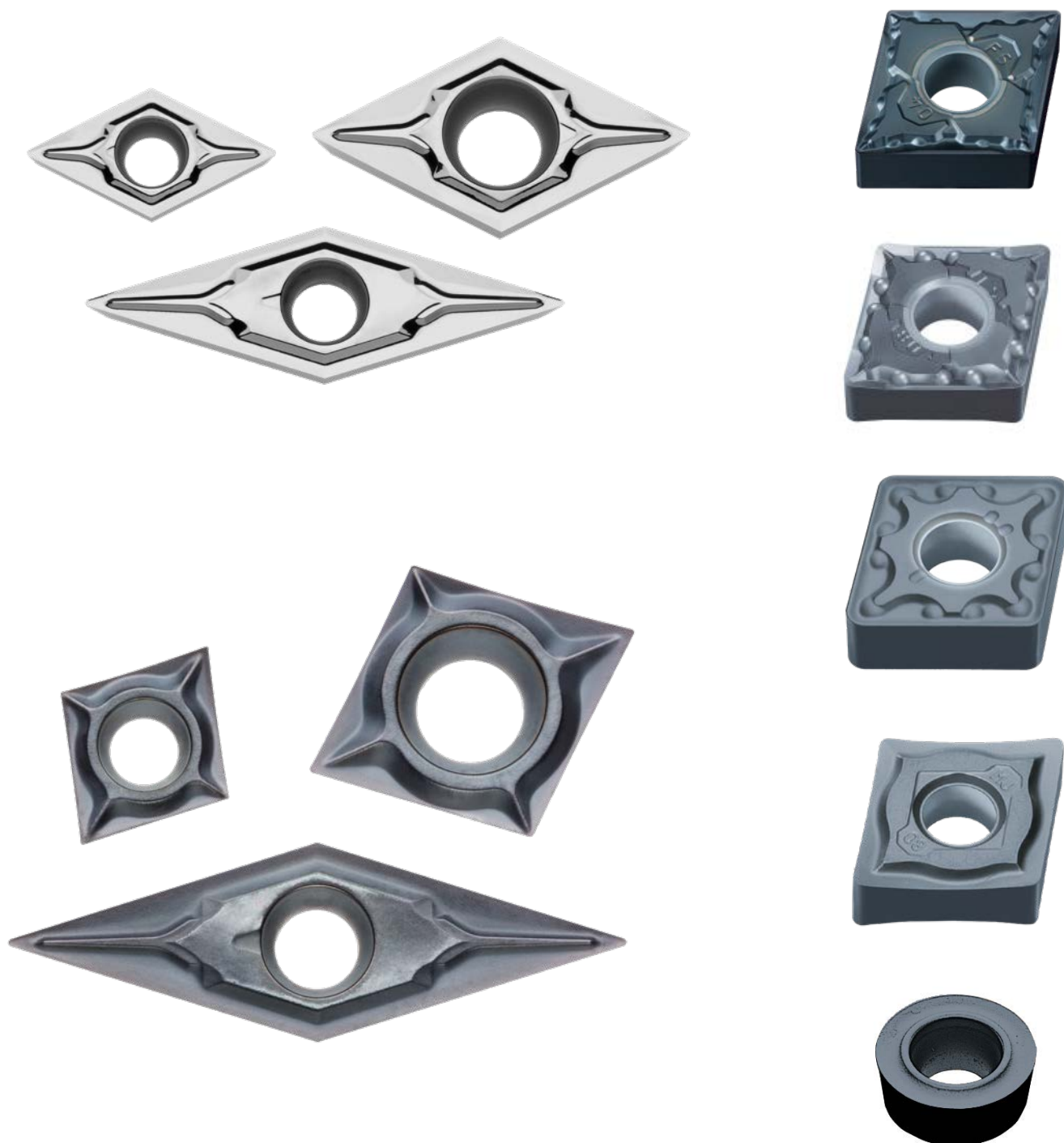

En savoir plus...

B214

www.mhg-mediastore.net



MP9005 / MP9015 / MP9025

NUANCE REVÊTUE PVD

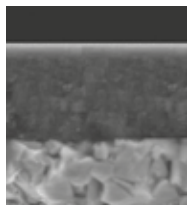

..... Technologie de revêtement monocouche ALTiN enrichi en Al

..... Substrat spécial en carbure fritté

TENEUR ÉLEVÉE EN ALUMINIUM ET COMPARAISON AVEC LES REVÊTEMENTS CONVENTIONNELS

La nouvelle technologie de revêtement monocouche ALTiN enrichi aluminium offre une stabilisation face aux matériaux de haute dureté et permet d'améliorer fortement la résistance à l'usure et au collage.

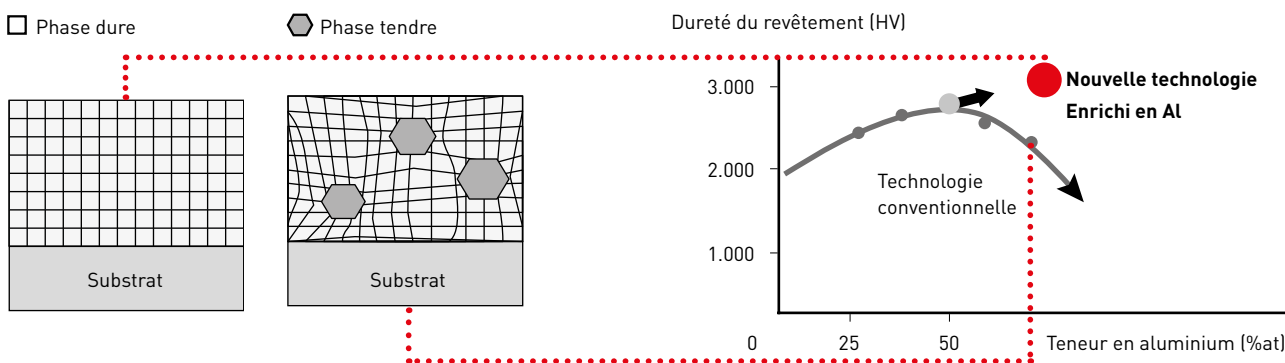

MT9005 / MT9015

NUANCES DE CARBURE NON REVÊTU

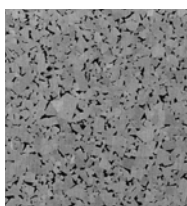

MT9015

ISO	Nuance	Concept	Application
S	S05	MP9005/MT9005 Nuance résistante à l'usure	Alliage réfractaire Ébauche moyenne - Finition
	S10	MP9015 Premier choix pour un usage général	Alliage réfractaire Ébauche - semi-finition
	S15	MP9025 Nuance résistante à l'écaillage, pour conditions instables	Alliages réfractaires Coupe interrompue, ébauche
		MT9015 Nouvelle nuance polie à arête de coupe tranchante assurant une excellente résistance à l'usure et à l'écaillage	Alliage de titane Coupe générale

ISO	PVD	
S	S01	MP9005, MT9005
	S10	MP9015, MT9015
	S20	MP9025, MT9015
	S25	MP9025
	S30	

SYSTÈME DE BRISE-COPEAUX – PLAQUETTES NÉGATIVES / PLAQUETTES NÉGATIVES DE PRÉCISION

Tolérance		Caractéristiques		Géométrie de coupe	
FINITION					
M	FS	NEW	<p><i>Plaquettes négatives de précision</i></p> <p>PREMIER CHOIX POUR LA FINITION DES RÉFRACTAIRES</p> <p>Excellent contrôle du copeau à faible profondeur de passe. Le grand angle de coupe et l'arête affûtée assurent une excellente acuité.</p>	<p>Pointe 25° 0.22</p> <p>Flancs 25° 0.44</p>	
SEMI-FINITION					
M	LS	NEW	<p><i>Plaquettes négatives / Plaquettes négatives de précision</i></p> <p>PREMIÈRE RECOMMANDATION POUR LA SEMI-FINITION DES RÉFRACTAIRES</p> <p>Amélioration de l'évacuation des copeaux pour des profondeurs de coupe plus petites que le rayon R.</p>	<p>Pointe 20° 0.4</p> <p>Flancs 20° 0.6</p>	
M	MJ		<p><i>Plaquettes négatives</i></p> <p>PREMIÈRE RECOMMANDATION POUR LA SEMI-FINITION DES RÉFRACTAIRES</p> <p>Brise-copeaux double faces, Brise-copeaux simple face (D Type, V Type). L'arête tranchante procure un bon état de surface. Idéal pour les alliages réfractaires et alliages titanes. L'arête incurvée permet la bonne évacuation des copeaux.</p>	<p>Pointe 13°</p> <p>Flancs 9°</p>	
ÉBAUCHE MOYENNE					
M	MS		<p><i>Plaquettes négatives</i></p> <p>PREMIÈRE RECOMMANDATION POUR L'ÉBAUCHE MOYENNE DES ACIERS INOXYDABLES, DE CONSTRUCTIONS ET RÉFRACTAIRES</p> <p>Brise-copeaux double faces. L'acuité de l'arête donne de meilleures performances.</p>	<p>Pointe 25° 0.5 / 15°</p> <p>Flancs 25° 0.5 / 15°</p>	
M	MA		<p><i>Plaquettes négatives</i></p> <p>BRISE-COPEAUX MULTI-ASSIST POUR L'ÉBAUCHE MOYENNE DE RÉFRACTAIRES</p> <p>Brise-copeaux à double face. Témoin positif permettant une coupe précise.</p>	<p>Pointe 22° 0.2 / 6°</p> <p>Flancs 22° 0.2 / 6°</p>	
ÉBAUCHE					
M	RS		<p><i>Plaquettes négatives</i></p> <p>PREMIÈRE RECOMMANDATION POUR L'ÉBAUCHE DES RÉFRACTAIRES</p> <p>Même avec de faible vitesse de coupe, le témoin positif empêche le collage et l'abrasion avec un très bon contrôle copeaux.</p>	<p>Pointe 20° 0.2 / 10°</p> <p>Flancs 20° 0.2</p>	

PLAGE DE CONTRÔLE DES COPEAUX

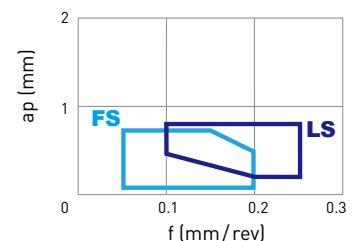
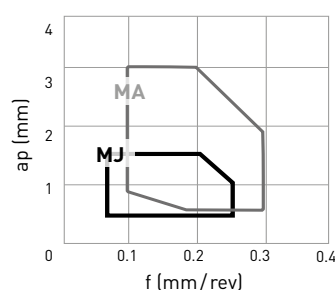
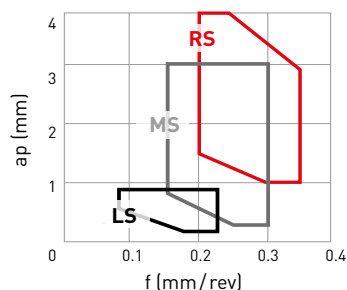

CNGG, DNGG

PLAQUETTES NÉGATIVES (AVEC TROU)

S

Classe G

CNGG

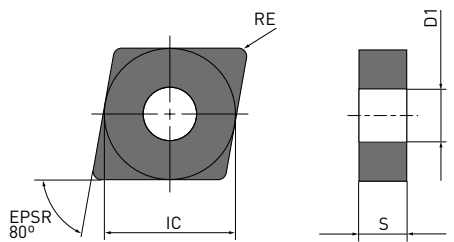

IDENTIFICATION DU BRISE-COPEAUX

APPLICATION





LS

FS

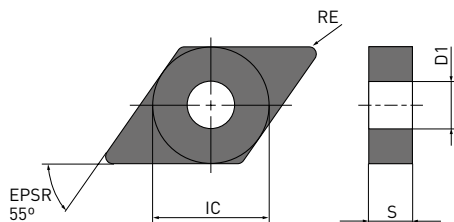
DNGG



Référence	 	MP9005	MP9015	MP9025	MT9015	IC	S	RE	D1
CNGG1204V5-FS	F	●	●		★	12.7	4.76	0.05	5.16
CNGG120401-FS	F	●	●	●	★	12.7	4.76	0.1	5.16
CNGG120402-FS	F	●	●	●	★	12.7	4.76	0.2	5.16
CNGG120404-FS	F	●	●	●	★	12.7	4.76	0.4	5.16
CNGG120408-FS	F	●	●	●	★	12.7	4.76	0.8	5.16
CNGG120402-LS	L	●	●	●	★	12.7	4.76	0.2	5.16
CNGG120404-LS	L	●	●	●	★	12.7	4.76	0.4	5.16
CNGG120408-LS	L	●	●	●	★	12.7	4.76	0.8	5.16
DNGG150402-FS	F	●	●	●	★	12.7	4.76	0.2	5.16
DNGG150404-FS	F	●	●	●	★	12.7	4.76	0.4	5.16
DNGG150408-FS	F	●	●	●	★	12.7	4.76	0.8	5.16
DNGG150604-FS	F	●	●	●	★	12.7	6.35	0.4	5.16
DNGG150608-FS	F	●	●	●	★	12.7	6.35	0.8	5.16
DNGG150402-LS	L	●	●	●	★	12.7	4.76	0.2	5.16
DNGG150404-LS	L	●	●	●	★	12.7	4.76	0.4	5.16
DNGG150408-LS	L	●	●	●	★	12.7	4.76	0.8	5.16
DNGG150604-LS	L	●	●	●	★	12.7	6.35	0.4	5.16
DNGG150608-LS	L	●	●	●	★	12.7	6.35	0.8	5.16

TNGG, VNGG

PLAQUETTES NÉGATIVES (AVEC TROU)

S

Classe G

TNGG

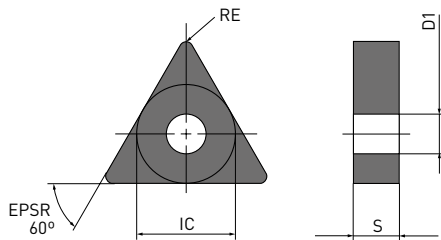

IDENTIFICATION DU BRISE-COPEAUX

APPLICATION





LS

FS

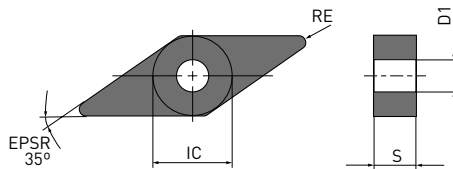
VNGG





Référence	 	MP9005	MP9015	MP9025	MT9015	IC	S	RE	D1
TNGG160402-FS	F	●	●	●	★	9.525	4.76	0.2	3.81
TNGG160404-FS	F	●	●	●	★	9.525	4.76	0.4	3.81
TNGG160408-FS	F	●	●	●	★	9.525	4.76	0.8	3.81
TNGG160402-LS	L	●	●	●	★	9.525	4.76	0.2	3.81
TNGG160404-LS	L	●	●	●	★	9.525	4.76	0.4	3.81
TNGG160408-LS	L	●	●	●	★	9.525	4.76	0.8	3.81
VNGG1604V5-FS	F	●	●		★	9.525	4.76	0.05	3.81
VNGG160401-FS	F	●	●	●	★	9.525	4.76	0.1	3.81
VNGG160402-FS	F	●	●	●	★	9.525	4.76	0.2	3.81
VNGG160404-FS	F	●	●	●	★	9.525	4.76	0.4	3.81
VNGG160408-FS	F	●	●	●	★	9.525	4.76	0.8	3.81
VNGG160402-LS	L	●	●	●	★	9.525	4.76	0.2	3.81
VNGG160404-LS	L	●	●	●	★	9.525	4.76	0.4	3.81
VNGG160408-LS	L	●	●	●	★	9.525	4.76	0.8	3.81



MP / MT9000

CONDITIONS DE COUPE RECOMMANDÉES



PLAQUETTES NÉGATIVES

Matière	Conditions			Nuance	Vc	f	ap
M Inox à durcissement structural (PH) (17-4 PH)	●	L	LS	MP9005	125-175	0.10-0.25	0.2-0.8
		M	MS	MP9005	115-160	0.10-0.25	0.5-4.0
		R	RS	MP9015	105-150	0.20-0.35	1.0-4.0
	●	L	LS	MP9015	120-165	0.10-0.25	0.2-0.8
		M	MS	MP9015	110-150	0.10-0.25	0.5-4.0
		R	RS	MP9015	100-140	0.20-0.35	1.0-4.0
	✱	L	LS	MP9025	80-95	0.10-0.25	0.2-0.8
		M	MS	MP9025	75-90	0.16-0.50	0.5-4.0
		R	RS	MP9025	70-85	0.20-0.35	1.0-4.0
S Alliage de titane (TA6V)	●	L	LS	MT9015	40-85	0.10-0.25	0.2-0.8
		M	MS	MT9015	40-80	0.10-0.25	0.5-4.0
		R	RS	MT9015	35-75	0.20-0.35	1.0-4.0
	●	L	LS	MT9015	40-85	0.10-0.25	0.2-0.8
		M	MS	MT9015	40-80	0.10-0.25	0.5-4.0
		R	RS	MT9015	35-75	0.20-0.35	1.0-4.0
S Alliage réfractaire base nickel (Inconel [®] 718, Hastelloy [®] , WASPALLOY [®]) Alliage base cobalt (Tribaloy [®] , Stellite [®])	●	L	LS	MP9005	30-110	0.10-0.25	0.2-0.8
		M	MS	MP9005	30-100	0.10-0.25	0.5-4.0
		R	RS	MP9015	20-75	0.20-0.35	1.0-4.0
	●	L	LS	MP9015	25-85	0.10-0.25	0.2-0.8
		M	MS	MP9015	25-80	0.10-0.25	0.5-4.0
		R	RS	MP9015	20-75	0.20-0.35	1.0-4.0
	✱	L	LS	MP9025	20-30	0.10-0.25	0.2-0.8
		M	MS	MP9025	20-30	0.10-0.25	0.5-4.0
		R	RS	MP9025	20-30	0.20-0.35	1.0-4.0

1. En cas de conditions de coupe instables, voir page 48 pour les brise-copeaux et nuances recommandées.
2. En alésage, ajuster les conditions de coupe en fonction du porte-à-faux.
3. Pour l'usinage des inox à durcissement structural, les nuances MC7015, MC7025 et MP7035 sont également recommandées.

NEW

PLAQUETTES NÉGATIVES DE PRÉCISION

Matière	Conditions			Nuance	Vc	f	ap
S Alliage de titane (TA6V)	●	F	FS	MT9015	45-95	0.05-0.20	0.1-0.7
		L	LS	MT9015	40-85	0.10-0.25	0.2-0.8
		F	FS	MT9015	45-95	0.05-0.20	0.1-0.7
	●	L	LS	MT9015	40-85	0.10-0.25	0.2-0.8
		F	FS	MT9015	45-95	0.05-0.20	0.1-0.7
		L	LS	MT9015	40-85	0.10-0.25	0.2-0.8
S Alliage réfractaire base nickel (Inconel [®] 718, Hastelloy [®] , WASPALLOY [®]) Alliage base cobalt (Tribaloy [®] , Stellite [®])	●	F	FS	MP9005	60-120	0.05-0.20	0.1-0.7
		L	LS	MP9005	55-110	0.10-0.25	0.2-0.8
		F	FS	MP9015	45-95	0.05-0.20	0.1-0.7
	●	L	LS	MP9015	40-85	0.10-0.25	0.2-0.8
		F	FS	MP9025	35-50	0.05-0.20	0.1-0.7
		L	LS	MP9025	30-45	0.10-0.25	0.2-0.8

Conditions d'utilisation : ● : Coupe stable ● : Coupe générale ✱ : Coupe instable

PERFORMANCES D'USINAGE

COMPARATIF DE L'ÉTAT DE SURFACE (INCONEL® 718)

La grande acuité d'arête et le bon contrôle du copeau assurent d'excellents états de surface.

Matière	Inconel® 718
Plaquette	CNGG120404
Vc (m/min)	50
f (mm/tr)	0.1
ap (mm)	0.2
Arrosage	Huile soluble

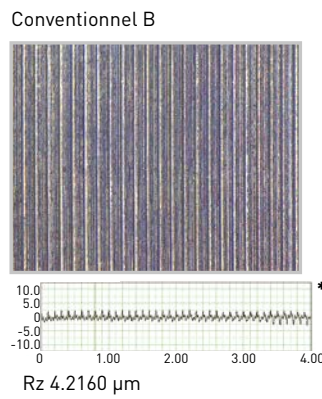
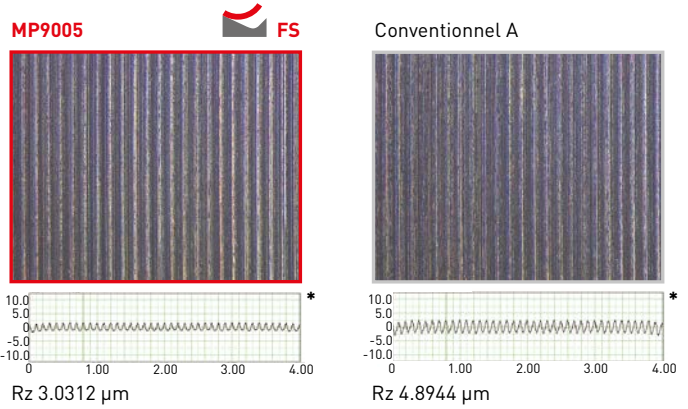

Matière	Inconel® 718
Plaquette	CNGG120404
Vc (m/min)	50
f (mm/tr)	0.1
ap (mm)	0.5
Arrosage	Huile soluble

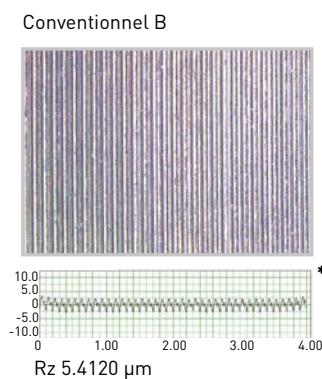
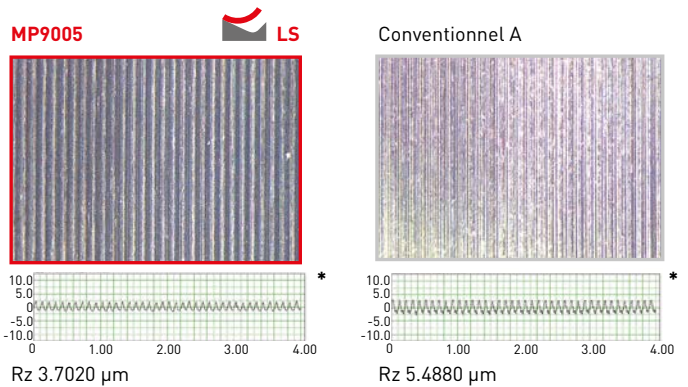

* Relevés de rugosimétrie
Échelle verticale: x 2.000.00
Échelle horizontale: x 50.00

MS6015 / MS7025 / MS9025

NUANCES MS - NUANCES À REVÊTEMENT PVD POUR
LE DÉCOLLETAGE

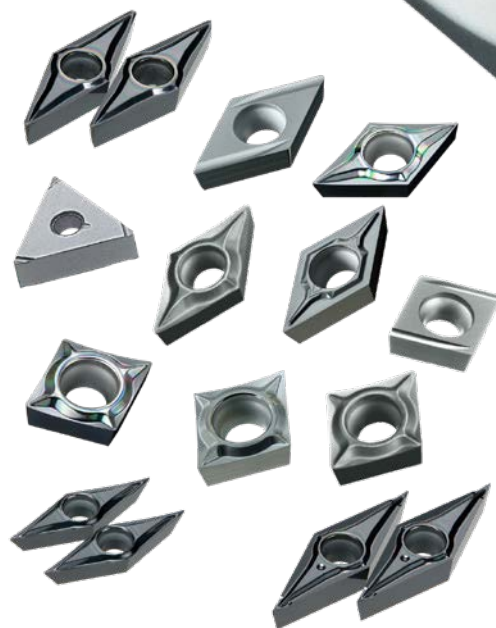

En savoir plus...

B275

www.mhg-mediastore.net

DIA  **EDGE**

MS6015 / MS7025 / MS9025

LE DÉVELOPPEMENT DU DÉCOLLETAGE



Les premières pièces décolletées étaient des pièces d'horlogerie. Ce type de fabrication s'est rapidement étendu à l'usinage de pièces électriques pour les appareils ménagers, les imprimantes ainsi que de pièces automobiles telles que les capteurs et les composants électriques. La grande précision des tours automatiques s'est également prêtée à l'usinage de pièces essentielles pour la vie quotidienne. Comme des implants médicaux, des composants de robots ou des pièces simples mais fondamentales comme des composants de robinetterie. Le développement du décolletage ne se montre cependant pas que dans l'élargissement des domaines d'application, mais également dans la variété des matières usinées ainsi que dans l'augmentation de la précision, de la productivité et de la qualité d'usinage.

CES ÉVOLUTIONS ONT RENDU NÉCESSAIRES DE NOUVELLES SOLUTIONS POUR

- Des formes de plus en plus complexes,
- Des matériaux de plus en plus difficiles à usiner,
- Des tolérances dimensionnelles de plus en plus serrées.



MITSUBISHI MATERIALS S'ENGAGE À DÉVELOPPER DES PRODUITS NOUVEAUX ET À COMMERCIALISER DES OUTILS INNOVANTS POUR ACCOMPAGNER L'INTRODUCTION DE NOUVELLES TECHNOLOGIES DE MACHINE ET L'UTILISATION DE MATIÈRES DE PLUS EN PLUS DIFFICILES À USINER PAR :

- Le développement de nouveaux revêtements adaptés aux matières usinées et aux spécificités du décolletage.
- L'amélioration de la résistance à l'usure, à l'écaillage et au collage.
- L'augmentation de la précision grâce à des géométries de coupe innovantes.

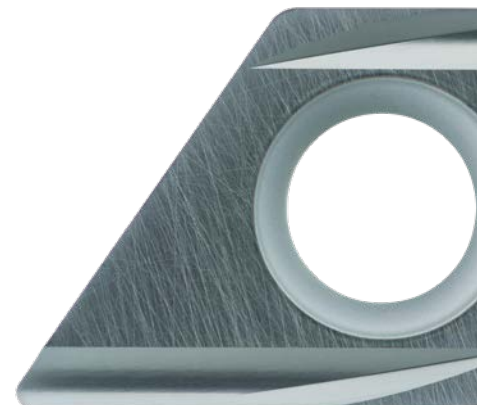

MS6015 / MS7025 / MS9025

CLASSIFICATION DES NUANCES

Matière	Mode de coupe	Nuance	P	PVD
P Aciers	Usinage continu ↑ ↓ Usinage au choc	Faible Moyen Élevé	MS6015	P10
				P20
M Aciers inoxydables	Usinage continu ↑ ↓ Usinage au choc	Faible Moyen Élevé	MS7025 MS9025	P30
				P40
				P50
S Alliage de titane (HRSA)	Usinage continu ↑ ↓ Usinage au choc	Faible Moyen Élevé	MS9025	M10
				M20
S Alliage de titane (HRSA)	Usinage continu ↑ ↓ Usinage au choc	Faible Moyen Élevé	MS9025	M30
				M40
				M50
				S10
				S20
S Alliage de titane (HRSA)	Usinage continu ↑ ↓ Usinage au choc	Faible Moyen Élevé	MS9025	S30
				S40
				S50
				S10
				S20

PLAGES D'APPLICATION POUR L'USINAGE D'INOX

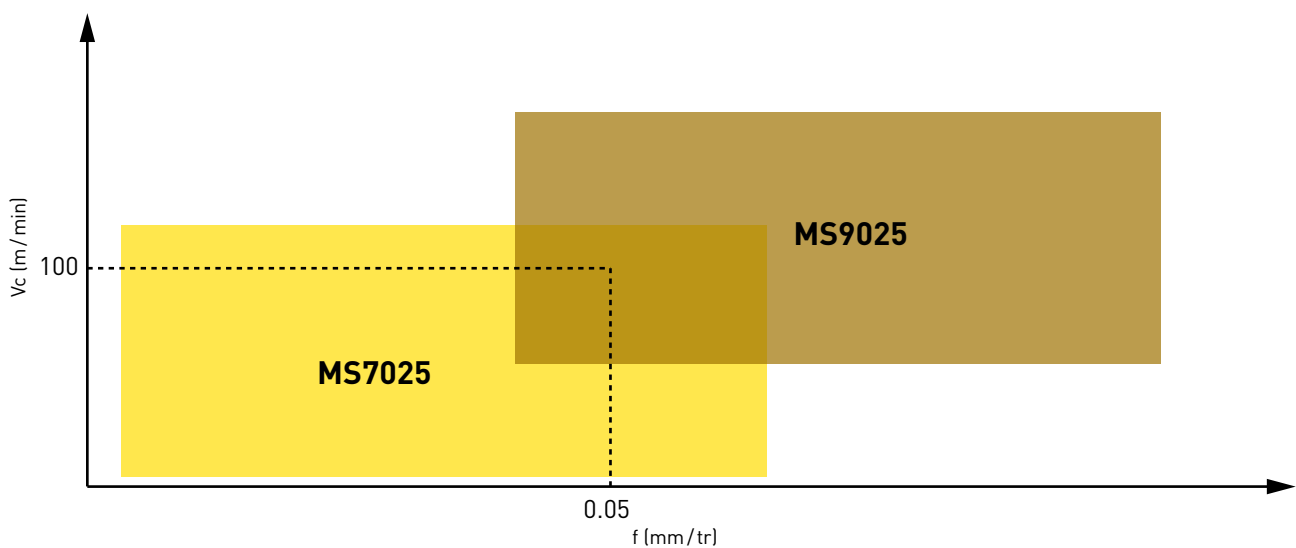

MS6015 / MS7025 / MS9025

LES NUANCES IDÉALES POUR LE DÉCOLLETAGE

Rayon de plaquette en tolérance négative.

Référence	DCGT11T302 M R-SN		02M R 0.2 mm (R 0.15 – R 0.20 mm)
	DCGT11T304 M -SMG		04M R 0.4 mm (R 0.35 – R 0.40 mm)

NOUVEAUX BRISE-COPEAUX DE COPIAGE

Brise-copeaux FS-P

Plaquettes positives de finition

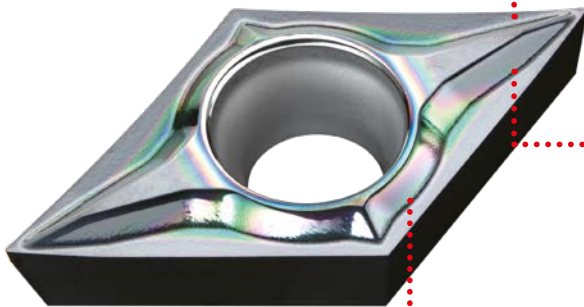

Arête de coupe incurvée

L'arête de coupe incurvée réduit les efforts de coupe et permet un bon enroulement des copeaux. Elle permet également l'entrée dans la pièce et réduit les vibrations.

Grande hauteur du brise-copeaux

La grande hauteur du brise-copeaux assure la fragmentation des copeaux et évite les rayures sur la pièce.

Brise-copeaux LS-P

Plaquettes positives polyvalentes

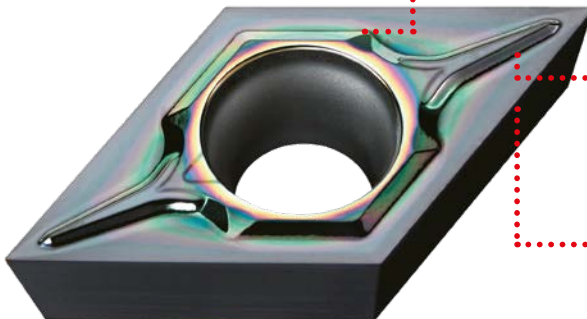

Polissage (surface miroir)

Résistance au collage et glissement du copeau grandement améliorés.

Grande poche

La grande poche améliore l'évacuation des copeaux lors de profondeurs importantes et empêche le bourrage de copeaux.

Arête de coupe droite

L'arête de coupe droite améliore grandement la résistance à l'écaillage à grande profondeur de passe.

ARÊTE DE COUPE DE TRÈS HAUTE QUALITÉ

Tenue de cote améliorée, bavures réduites.

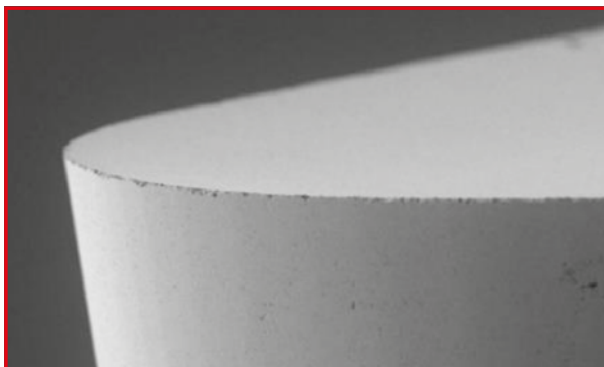

MS7025 / MS9025

Rz = 0.14 µm

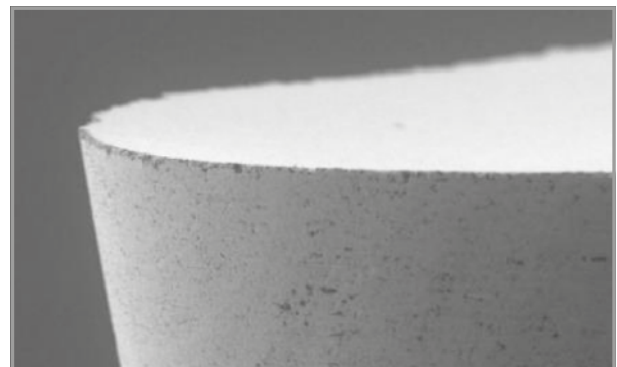

Conventionnel

Rz = 0.61 µm

MS9025

NOUVELLE TECHNOLOGIE : TOURNAGE VIBRATOIRE

L'utilisation d'une nouvelle technologie d'usinage pour faire vibrer délibérément l'outil par rapport au sens d'avance est un moyen efficace de contrôler les copeaux. Cela permet de fiabiliser les process d'usinage et de réduire les arrêts de machine.

Tournage classique



Fréquence de vibration =
0.75/tr



Fréquence de vibration =
1.25/tr

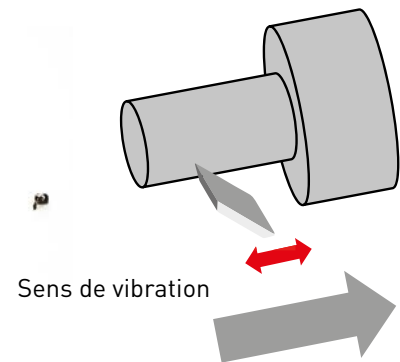

Défis de l'usinage vibratoire :

Par rapport à l'usinage classique, le risque d'écaillage est plus élevé en raison de la contrainte supplémentaire exercée sur l'arête de coupe et de l'écroûissage de la pièce.

AVANTAGES DU MS9025 EN USINAGE VIBRATOIRE



1. Excellente résistance à l'écaillage grâce au substrat tenace
2. Suppression de l'usure en entaille lors de l'usinage de réfractaires grâce à la taille optimisée des grains de carbure, ce qui augmente la conductivité thermique et réduit le température de l'arête de coupe.

Usure après 500 pièces (15 m d'usinage)

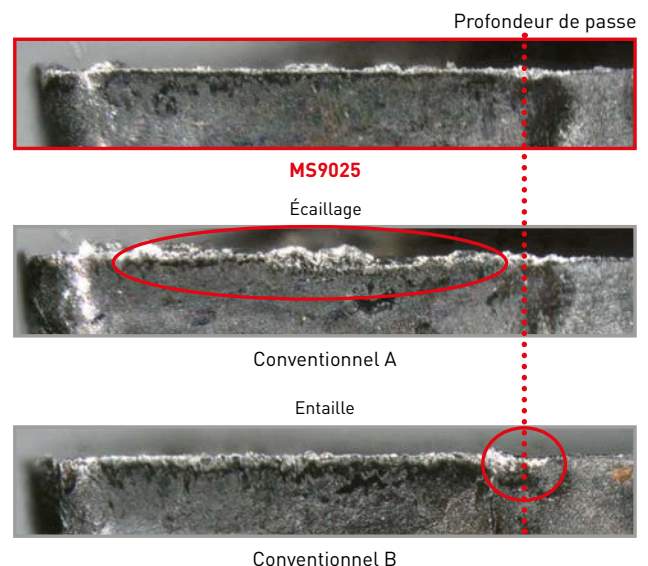



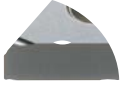
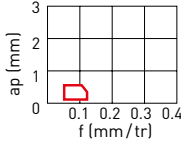





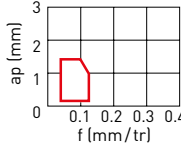
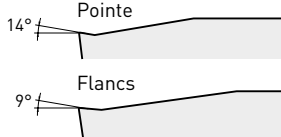
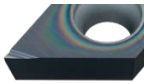
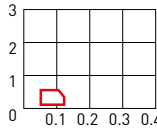

Matière	DIN X5CrNi18-10 (1.4301)
Plaquette	DCGT11T302M
Vc (m/min)	100
f (mm/tr)	0.08
ap (mm)	1.0
Fréquence de vibrations	1.25/tr
Mode de coupe	Chariotage Usinage continu Huile entière

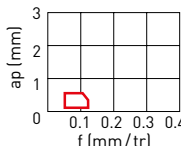

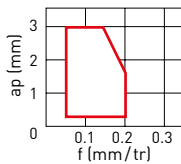
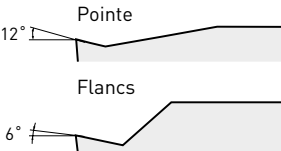
CLASSIFICATION – PLAQUETTES NÉGATIVES

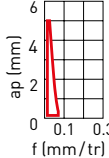
Tolérance		Caractéristiques	Acier carbone / Acier allié	Géométrie de coupe
FINITION				
G		FINITION DE PRÉCISION Brise-copeaux double faces. Brise-copeaux principal étroit pour un bon contrôle copeaux. L'arête tranchante procure un bon état de surface.		

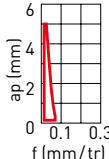
CLASSIFICATION – PLAQUETTES POSITIVES

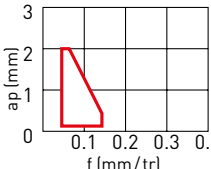
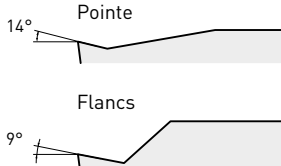
Tolérance		Caractéristiques	Acier carbone / Acier allié	Géométrie de coupe
FINITION				
		PREMIER CHOIX POUR LA FINITION DES ALLIAGES DE TITANE Idéale pour les alliages de titane, de chrome-cobalt et de cuivre. La grande acuité d'arête assure un bon état de surface. L'arête incurvée évite le frottement des copeaux sur la pièce. Le polissage de la face de coupe donne une finition miroir pour une meilleure résistance au collage.		
G		FINITION Brise-copeaux principal contrôlant la formation copeaux. Arête tranchante donnant un très bon état de surface.		
		FINITION Brise-copeaux principal contrôlant la formation copeaux. Arête tranchante donnant un très bon état de surface.		
SEMI-FINITION				
G		RECOMMANDATION POUR LA FINITION DU TITANE Également pour l'aluminium et le cuivre. Arête de coupe droite. Grande plage de contrôle du copeau. Plaquette polie pour éviter le collage.		
		SEMI-FINITION SUR TOURS AUTOMATIQUES Brise-copeaux parallèles. Excellent contrôle des copeaux à faible avance.		
ÉBAUCHE MOYENNE				
G		ÉBAUCHE MOYENNE EN DÉCOLLETAGE Brise-copeaux parallèle. Excellent contrôle du copeau à faible et moyenne avance.		
		SEMI-FINITION SUR TOURS AUTOMATIQUES Le brise-copeaux en D offre un bon contrôle des copeaux. La plaquette de classe G possède une grande acuité, ce qui permet un usinage très précis. Géométrie du brise-copeaux adaptée au copiage et au tournage arrière.		

MS6015 / MS7025 / MS9025

PLAQUETTES POSITIVES 5° À TROU

P **M** **S**

Classe G

VBGT



FS-P

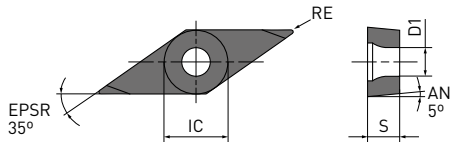

Référence		MS6015	MS7025	MS9025	IC	S	RE	D1
VBGT110301M-FS-P	F			●	6.35	3.18	0.1	2.9
VBGT110302M-FS-P	F			●	6.35	3.18	0.2	2.9
VBGT110304M-FS-P	F			●	6.35	3.18	0.4	2.9
VBGT160401M-FS-P	F			●	9.525	4.76	0.1	4.4
VBGT160402M-FS-P	F			●	9.525	4.76	0.2	4.4
VBGT160404M-FS-P	F			●	9.525	4.76	0.4	4.4
VBGT160408M-FS-P	F			●	9.525	4.76	0.8	4.4

MS6015 / MS7025 / MS9025



PLAQUETTES POSITIVES 7° À TROU

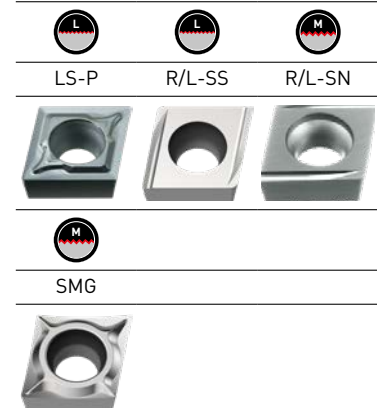
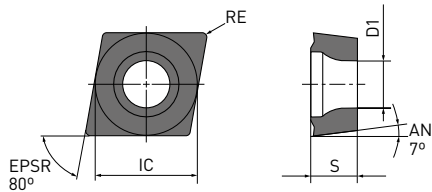

Classe G

CCGH/CCGT



Référence	 	MS6015	MS7025	MS9025	IC	S	RE*	D1
NEW CCGT0602V5M-LS-P	L			●	6.35	2.38	0.05	2.8
CCGT060201M-LS-P	L	●	●	●	6.35	2.38	0.1	2.8
CCGT060202M-LS-P	L	●	●	●	6.35	2.38	0.2	2.8
CCGT09T301M-LS-P	L	●	●	●	9.525	3.97	0.1	4.4
CCGT09T302M-LS-P	L	●	●	●	9.525	3.97	0.2	4.4
CCGT09T304M-LS-P	L	●	●	●	9.525	3.97	0.4	4.4
CCGT060201MR-SS	L	●			6.35	2.38	0.1	2.8
CCGT060201ML-SS	L	●			6.35	2.38	0.1	2.8
CCGT060202MR-SS	L	●			6.35	2.38	0.2	2.8
CCGT060202ML-SS	L	●			6.35	2.38	0.2	2.8
CCGT09T301MR-SS	L	●			9.525	3.97	0.1	4.4
CCGT09T301ML-SS	L	●			9.525	3.97	0.1	4.4
CCGT09T302MR-SS	L	●			9.525	3.97	0.2	4.4
CCGT09T302ML-SS	L	●			9.525	3.97	0.2	4.4
CCGT09T304MR-SS	L	●			9.525	3.97	0.4	4.4
CCGT09T304ML-SS	L	●			9.525	3.97	0.4	4.4
CCGT060201MR-SN	M	●	●	●	6.35	2.38	0.1	2.8
CCGT060201ML-SN	M	●			6.35	2.38	0.1	2.8
CCGT060202MR-SN	M	●	●	●	6.35	2.38	0.2	2.8
CCGT060202ML-SN	M	●			6.35	2.38	0.2	2.8
CCGT09T301MR-SN	M	●	●	●	9.525	3.97	0.1	4.4
CCGT09T301ML-SN	M	●			9.525	3.97	0.1	4.4
CCGT09T302MR-SN	M	●	●	●	9.525	3.97	0.2	4.4
CCGT09T302ML-SN	M	●			9.525	3.97	0.2	4.4
CCGT09T304MR-SN	M	●	●	●	9.525	3.97	0.4	4.4
CCGT09T304ML-SN	M	●			9.525	3.97	0.4	4.4
CCGT060201M-SMG	M	●			6.35	2.38	0.1	2.8
CCGT060202M-SMG	M	●			6.35	2.38	0.2	2.8
CCGT060204M-SMG	M	●			6.35	2.38	0.4	2.8
CCGT09T301M-SMG	M	●			9.525	3.97	0.1	4.4
CCGT09T302M-SMG	M	●			9.525	3.97	0.2	4.4
CCGT09T304M-SMG	M	●			9.525	3.97	0.4	4.4

Valeur nominale [maximale].



MS6015 / MS7025 / MS9025



PLAQUETTES POSITIVES 7° À TROU

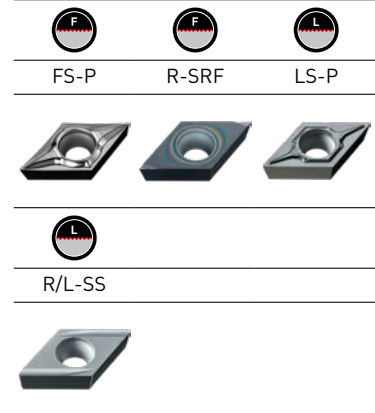
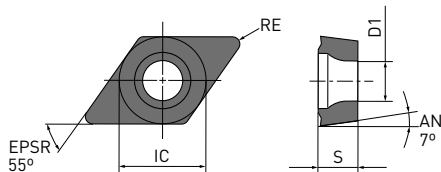

Classe G

DCGT



Référence	 	MS6015	MS7025	MS9025	IC	S	RE*	D1
DCGT070201M-FS-P	F		●	●	6.35	2.38	0.1	2.8
DCGT070202M-FS-P	F		●	●	6.35	2.38	0.2	2.8
DCGT070204M-FS-P	F		●	●	6.35	2.38	0.4	2.8
DCGT11T301M-FS-P	F		●	●	9.525	3.97	0.1	4.4
DCGT11T302M-FS-P	F		●	●	9.525	3.97	0.2	4.4
DCGT11T304M-FS-P	F		●	●	9.525	3.97	0.4	4.4
DCGT11T301MR-SRF	F		●	●	9.525	3.97	0.1	4.4
DCGT11T302MR-SRF	F		●	●	9.525	3.97	0.2	4.4
DCGT11T304MR-SRF	F		●	●	9.525	3.97	0.4	4.4
NEW DCGT0702V5M-LS-P	L			●	6.35	2.38	0.05	2.8
DCGT070201M-LS-P	L	●	●	●	6.35	2.38	0.1	2.8
DCGT070202M-LS-P	L	●	●	●	6.35	2.38	0.2	2.8
DCGT070204M-LS-P	L	●	●	●	6.35	2.38	0.4	2.8
DCGT11T301M-LS-P	L	●	●	●	9.525	3.97	0.1	4.4
DCGT11T302M-LS-P	L	●	●	●	9.525	3.97	0.2	4.4
DCGT11T304M-LS-P	L	●	●	●	9.525	3.97	0.4	4.4
DCGT070201MR-SS	L	●			6.35	2.38	0.1	2.8
DCGT070201ML-SS	L	●			6.35	2.38	0.1	2.8
DCGT070202MR-SS	L	●			6.35	2.38	0.2	2.8
DCGT070202ML-SS	L	●			6.35	2.38	0.2	2.8
DCGT11T301MR-SS	L	●			9.525	3.97	0.1	4.4
DCGT11T301ML-SS	L	●			9.525	3.97	0.1	4.4
DCGT11T302MR-SS	L	●			9.525	3.97	0.2	4.4
DCGT11T302ML-SS	L	●			9.525	3.97	0.2	4.4
DCGT11T304MR-SS	L	●			9.525	3.97	0.4	4.4
DCGT11T304ML-SS	L	●			9.525	3.97	0.4	4.4

Valeur nominale (maximale).



MS6015 / MS7025 / MS9025

PLAQUETTES POSITIVES 7° À TROU



Classe G

DCGT

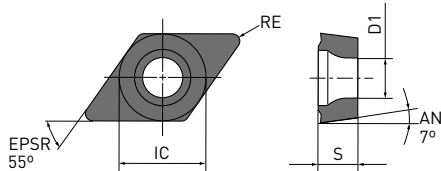
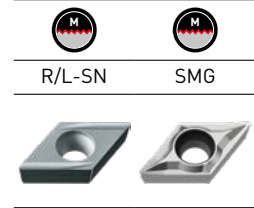

Référence		MS6015	NEW MS7025	NEW MS9025	IC	S	RE*	D1
DCGT070201MR-SN	M	●	●	●	6.35	2.38	0.1	2.8
NEW DCGT070201ML-SN	M	●	★	★	6.35	2.38	0.1	2.8
DCGT070202MR-SN	M	●	●	●	6.35	2.38	0.2	2.8
NEW DCGT070202ML-SN	M	●	★	★	6.35	2.38	0.2	2.8
DCGT070204MR-SN	M	●	●	●	6.35	2.38	0.4	2.8
DCGT11T301MR-SN	M	●	●	●	9.525	3.97	0.1	4.4
NEW DCGT11T301ML-SN	M	●	★	★	9.525	3.97	0.1	4.4
DCGT11T302MR-SN	M	●	●	●	9.525	3.97	0.2	4.4
NEW DCGT11T302ML-SN	M	●	★	★	9.525	3.97	0.2	4.4
DCGT11T304MR-SN	M	●	●	●	9.525	3.97	0.4	4.4
NEW DCGT11T304ML-SN	M	●	★	★	9.525	3.97	0.4	4.4
DCGT070201M-SMG	M	●			6.35	2.38	0.1	2.8
DCGT070202M-SMG	M	●			6.35	2.38	0.2	2.8
DCGT070204M-SMG	M	●			6.35	2.38	0.4	2.8
DCGT11T301M-SMG	M	●			9.525	3.97	0.1	4.4
DCGT11T302M-SMG	M	●			9.525	3.97	0.2	4.4
DCGT11T304M-SMG	M	●			9.525	3.97	0.4	4.4

Valeur nominale (maximale).

65

MS6015 / MS7025 / MS9025

PLAQUETTES POSITIVES 7° À TROU

P **M** **S**

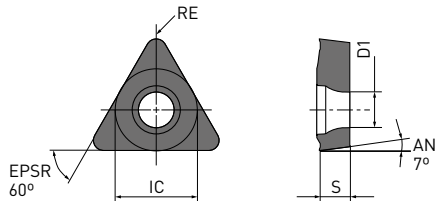
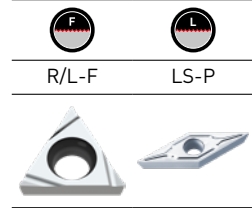

Classe G

TCGT

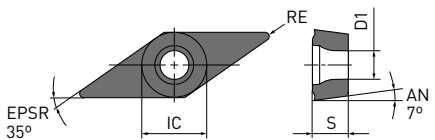

VCGT



Référence	 	MS6015	MS7025	NEW MS9025	IC	S	RE*	D1
TCGT060101MR-F	F	●			3.97	1.59	0.1	2.3
TCGT060101ML-F	F	●			3.97	1.59	0.1	2.3
TCGT060102MR-F	F	●			3.97	1.59	0.2	2.3
TCGT060102ML-F	F	●			3.97	1.59	0.2	2.3
TCGT060104MR-F	F	●			3.97	1.59	0.4	2.3
TCGT060104ML-F	F	●			3.97	1.59	0.4	2.3
NEW VCGT110301M-FS-P	F			●	6.35	3.18	0.1	2.8
NEW VCGT110302M-FS-P	F			●	6.35	3.18	0.2	2.8
NEW VCGT110304M-FS-P	F			●	6.35	3.18	0.4	2.8
NEW VCGT110301M-LS-P	L		●	●	6.35	3.18	0.1	2.8
NEW VCGT110302M-LS-P	L		●	●	6.35	3.18	0.2	2.8
NEW VCGT110304M-LS-P	L		●	●	6.35	3.18	0.4	2.8
NEW VCGT130301M-LS-P	L			●	7.94	3.18	0.1	3.4
NEW VCGT130302M-LS-P	L			●	7.94	3.18	0.2	3.4
NEW VCGT130304M-LS-P	L			●	7.94	3.18	0.4	3.4

*1 Valeur nominale (maximale).



MS6015 / MS7025 / MS9025

PLAQUETTES POSITIVES 11° À TROU

P **M** **S**

Classe G

VPGT

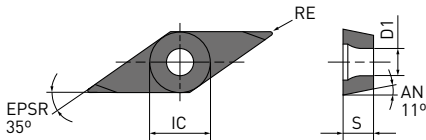











































Référence		MS6015	MS7025	MS9025	IC	S	RE	D1
VPGT080201M-FS-P	F			●	4.76	2.38	0.1	2.42
VPGT080202M-FS-P	F			●	4.76	2.38	0.2	2.42
VPGT110301M-FS-P	F			●	6.35	3.18	0.1	2.85
VPGT110302M-FS-P	F			●	6.35	3.18	0.2	2.85

65

MS6015 / MS7025 / MS9025

CONDITIONS DE COUPE RECOMMANDÉES

Matière	Dureté	Conditions			Nuance	Vc	f	ap
								
Fer pur Acier allié	—		F	MS6015	FS	150 (50 – 250)	0.01 – 0.15	0.2 – 0.7
			F	MS6015	R/L-F	150 (50 – 250)	0.01 – 0.15	0.1 – 0.5
			L	MS6015	LS-P	150 (50 – 250)	0.01 – 0.15	0.3 – 3.0
			L	MS6015	R/L-SS	150 (50 – 250)	0.01 – 0.15	0.2 – 1.0
			M	MS6015	R/L-SN	150 (50 – 250)	0.01 – 0.15	0.1 – 0.5
			M	MS6015	SMG	150 (50 – 250)	0.01 – 0.15	0.1 – 2.0
P Fer doux magnétique	—		F	FS	MS6015	200 (150 – 250)	0.01 – 0.15	0.2 – 0.7
			F	FS-P	MS7025	200 (100 – 300)	0.01 – 0.06	0.2 – 0.7
			F	R/L-F	MS6015	200 (150 – 250)	0.01 – 0.15	0.1 – 0.5
			F	R-SRF	MS7025	200 (100 – 300)	0.01 – 0.06	0.1 – 0.5
			L	LS-P	MS6015	200 (150 – 250)	0.01 – 0.15	0.1 – 0.5
			L	LS-P	MS7025	200 (100 – 300)	0.01 – 0.06	0.1 – 0.5
			L	R/L-SS	MS6015	200 (150 – 250)	0.01 – 0.15	0.2 – 1.0
			M	R/L-SN	MS6015	200 (150 – 250)	0.01 – 0.15	0.1 – 0.5
			M	R/L-SN	MS7025	200 (100 – 300)	0.01 – 0.06	0.1 – 0.5
Aciers carbone et alliés	180–280HB		F	MS6015	FS	100 (50 – 150)	0.01 – 0.15	0.2 – 0.7
			F	MS6015	R/L-F	100 (50 – 150)	0.01 – 0.15	0.1 – 0.5
			L	MS6015	LS-P	100 (50 – 150)	0.01 – 0.15	0.3 – 3.0
			L	MS6015	R/L-SS	100 (50 – 150)	0.01 – 0.15	0.2 – 1.0
			M	MS6015	R/L-SN	100 (50 – 150)	0.01 – 0.15	0.1 – 0.5
			M	MS6015	SMG	100 (50 – 150)	0.01 – 0.15	0.1 – 2.0
Acier inoxydable austénitique	—		F	MS7025	FS	60 (40 – 100)	0.01 – 0.08	0.2 – 0.7
			F	MS9025	FS-P	100 (60 – 150)	0.04 – 0.15	0.2 – 0.7
			F	MS7025	R/L-F	60 (40 – 100)	0.01 – 0.08	0.1 – 0.5
			F	MS9025	R-SRF	100 (60 – 150)	0.04 – 0.15	0.1 – 0.5
			L	MS7025	LS-P	60 (40 – 100)	0.01 – 0.08	0.3 – 3.0
			L	MS9025	LS-P	100 (60 – 150)	0.05 – 0.15	0.3 – 3.0
			M	MS7025	R-SN	60 (40 – 100)	0.01 – 0.08	0.1 – 5.0
			M	MS9025	R-SN	100 (60 – 150)	0.05 – 0.15	0.1 – 5.0
M Acier inoxydable ferritique ou martensitique	—		F	MS7025	FS-P	60 (40 – 100)	0.01 – 0.08	0.2 – 0.7
			F	MS7025	R-SRF	60 (40 – 100)	0.01 – 0.08	0.1 – 0.5
			L	MS7025	LS-P	60 (40 – 100)	0.01 – 0.08	0.3 – 3.0
Aciers inoxydables martensitiques (Z100CD17, Z33C13, etc.)	Dureté 230HBW		L	MS7025	R-SN	60 (40 – 100)	0.01 – 0.08	0.1 – 5.0
			F	MS7025	FS-P	80 (40 – 160)	0.02 – 0.08	0.2 – 1.8
			F	MS9025	FS-P	100 (50 – 180)	0.04 – 0.12	0.2 – 1.8
			F	MS7025	R-SRF	80 (40 – 160)	0.03 – 0.08	0.1 – 0.5
			F	MS9025	R-SRF	100 (50 – 180)	0.05 – 0.12	0.1 – 0.5
			L	MS7025	LS-P	80 (40 – 160)	0.02 – 0.10	0.3 – 3.0
			L	MS9025	LS-P	100 (50 – 180)	0.04 – 0.15	0.3 – 3.0
			M	MS7025	R-SN	80 (40 – 160)	0.01 – 0.10	0.1 – 5.0

MS6015 / MS7025 / MS9025

CONDITIONS DE COUPE RECOMMANDÉES

Matière	Dureté	Conditions		Nuance		Vc	f	ap
M Inox à durcissement structural (PH) (17-4PH, 15-5PH etc.)	<450HB	●	F	MS7025	FS-P	60 (40 – 80)	0.01 – 0.10	0.1 – 1.4
		●	F	MS9025	FS-P	70 (50 – 100)	0.03 – 0.15	0.1 – 1.4
		●	F	MS7025	R-SRF	60 (40 – 80)	0.01 – 0.10	0.1 – 0.5
		●	F	MS9025	R-SRF	70 (50 – 100)	0.03 – 0.15	0.1 – 0.5
		●	L	MS7025	LS-P	60 (40 – 80)	0.04 – 0.10	0.2 – 3.0
		●	L	MS9025	LS-P	70 (50 – 100)	0.04 – 0.15	0.2 – 3.0
		●	M	MS7025	R-SN	60 (40 – 80)	0.03 – 0.10	0.3 – 3.0
		●	M	MS9025	R-SN	70 (50 – 100)	0.04 – 0.15	0.2 – 3.0
S Inox réfractaires (Z10CAS24, etc.)	—	●	F	MS9025	FS-P	80 (40 – 140)	0.04 – 0.12	0.2 – 1.4
		●	F	MS9025	R-SRF	80 (40 – 140)	0.05 – 0.12	0.1 – 0.5
		●	L	MS9025	LS-P	80 (40 – 140)	0.04 – 0.15	0.3 – 3.0
		●	M	MS9025	R-SN	80 (40 – 140)	0.01 – 0.10	0.1 – 5.0

SÉRIE MC5100

NUANCES DE TOURNAGE FONTE À REVÊTEMENT CVD
POUR TOUTES APPLICATIONS DE L'USINAGE
À GRANDE VITESSE À LA COUPE AU CHOC



En savoir plus...

B269

www.mhg-mediastore.net

DIA EDGE

SÉRIE MC5100

NUANCES DE TOURNAGE FONTE À REVÊTEMENT CVD

UNE GAMME DE NUANCES OPTIMALE POUR TOUTES LES APPLICATIONS

La fabrication par fonderie permet d'obtenir des pièces de géométrie complexe. Les différentes familles de fontes sollicitent les outils de manières très différentes et créent différentes formes d'usure. Une des difficultés dans l'usinage de pièces moulées peut consister dans la présence de zones de coupe au choc et de zones de coupe continue dans la même opération. Pour répondre à ces défis, Mitsubishi Materials a créé une série de nuances capables d'usiner avec succès tous les types de matériaux en fonte et de géométries de composants.

FORMATION DES COPEAUX DE FONTE



„SUPER“ NANO TEXTURE

La technologie de nano-texturation standard a été grandement améliorée, le revêtement Al_2O_3 Mitsubishi Materials est la nouvelle référence du marché. La durée de vie est augmentée de manière significative grâce à la finesse et à l'orientation des cristaux de revêtement.

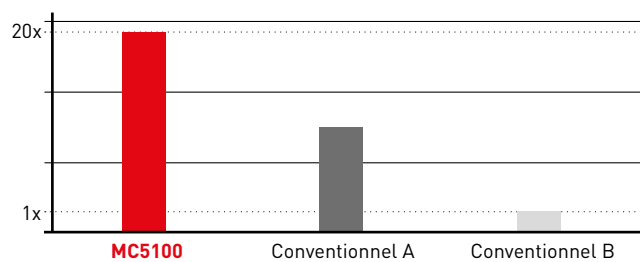

Teneur en grains d' Al_2O_3 avec la même orientation

ORIENTATION CRISTALLINE

(Représentation graphique)

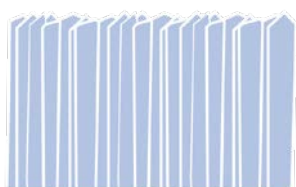

Super nano-revêtement

L'homogénéité de taille et d'orientation des grains est considérablement améliorée.



Nano-revêtement

L'homogénéité de taille et d'orientation des grains est améliorée.



Plaquettes CVD conventionnelles

La taille et l'orientation des grains sont inégales.

SÉRIE MC5100

NUANCES DE TOURNAGE FONTE À REVÊTEMENT CVD

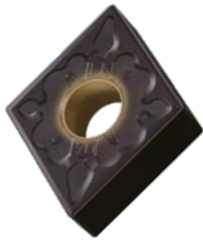

MC5105

POUR LA COUPE À HAUTE VITESSE DE LA FONTE GRISE

Excellente résistance à l'usure en tournage de fonte grise à des vitesses de coupe jusqu'à 1000 m / min.



MC5115

PREMIÈRE PRÉCONISATION POUR LA FONTE DUCTILE

Empêche l'arrachement du revêtement pour éviter une usure prématurée. Excellente résistance à l'usure et à la l'écaillage en usinage de fonte ductile.

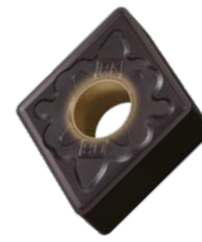

MC5125

POUR LE TOURNAGE LOURD ET LA COUPE AU CHOC DE FONTE DUCTILE

Nuance tenace à grande résistance à l'écaillage, pour le tournage lourd ou au choc de la fonte ductile.

COUCHES TOUGH-GRIP ET SUB-GRIP POUR L'USINAGE DE LA FONTE DUCTILE

La force d'adhésion supplémentaire entre les couches de revêtement (augmentée de 30%) évite l'écaillage lors de l'usinage de fonte ductile.

Adhésion du revêtement augmentée de 30% !



TOUGH-GRIP

Le dépôt de la couche d'accroche est contrôlé à l'échelle nanométrique, ce qui permet à la couche Tough-Grip d'atteindre des niveaux d'adhésion extrêmement élevés et d'éviter ainsi tout arrachement du revêtement.

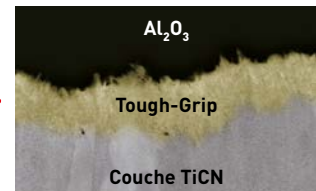

SUB-GRIP

En augmentant l'adhésion entre le substrat carbure et le revêtement, on obtient une nuance qui résiste à l'écaillage même en cas d'usinage au choc.



*Par rapport aux nuances conventionnelles Mitsubishi Materials.

LE MOT DU DÉVELOPPEUR

Étant donné que la fonte grise peut être usinée à des vitesses élevées (500 – 1000 m/min), il est important de rendre la couche de revêtement en Al_2O_3 aussi résistante que possible afin d'assurer la résistance à l'usure. L'accent a été mis sur l'orientation des cristaux et l'amélioration de la couche d'accroche. Le revêtement a également été modifié pour améliorer la résistance aux chocs malgré l'utilisation d'un substrat carbure plus dur que celui des conventionnels.

La fonte ductile est généralement usinée à des vitesses plus faibles (100 – 300 m/min), nous avons donc retravaillé la couche de TiCN qui présente une grande dureté.

En ce qui concerne les performances en coupe interrompue, il était difficile d'identifier la cause de l'écaillage des arêtes, mais les analyses d'usure ont révélé que la délamination du revêtement en était à l'origine. Une couche d'accroche avec le substrat carbure a donc été introduite.

La série MC5100 comporte donc 3 nuances pour répondre de façon optimale à chaque type de tournage de fonte. Ces nuances deviendront un outil indispensable pour les clients qui usinent des fontes.

SÉRIE MC5100

MC5105

POUR L'USINAGE À HAUTE VITESSE DE LA FONTE GRISE

Carbure de haute dureté pour une résistance à l'usure exceptionnelle.

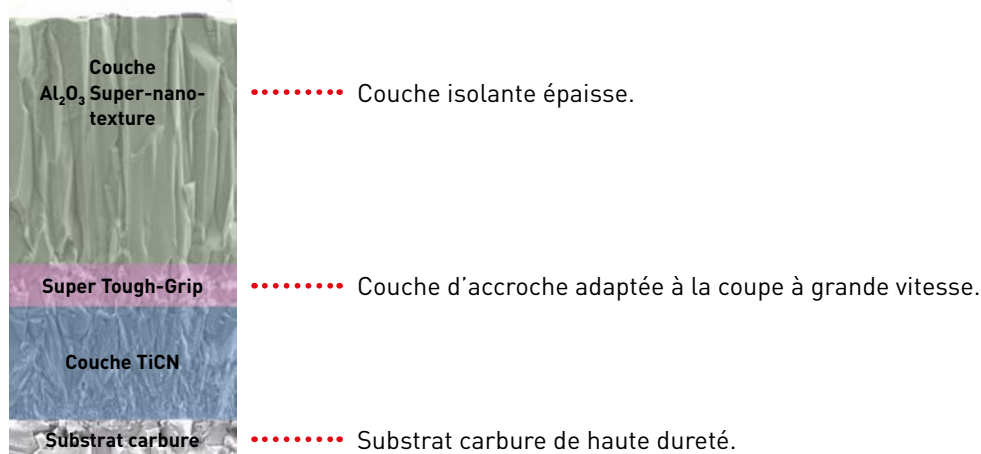

MC5115

PREMIÈRE PRÉCONISATION POUR LA FONTE DUCTILE

Excellent équilibre entre et résistance aux chocs et à l'usure.

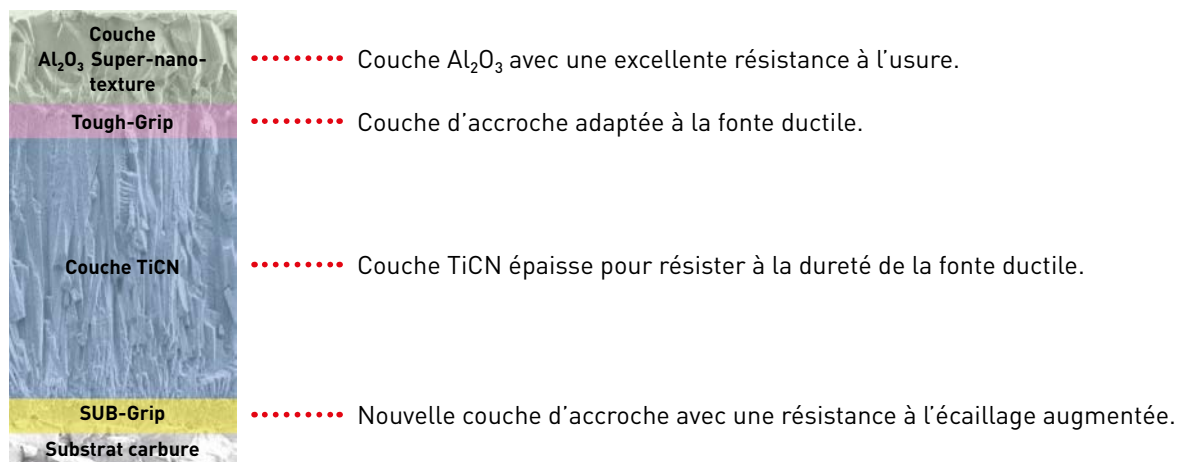

MC5125

POUR LE TOURNAGE LOURD OU AU CHOC DE FONTE DUCTILE

Nuance tenace résistant aux chocs et à l'écaillage.

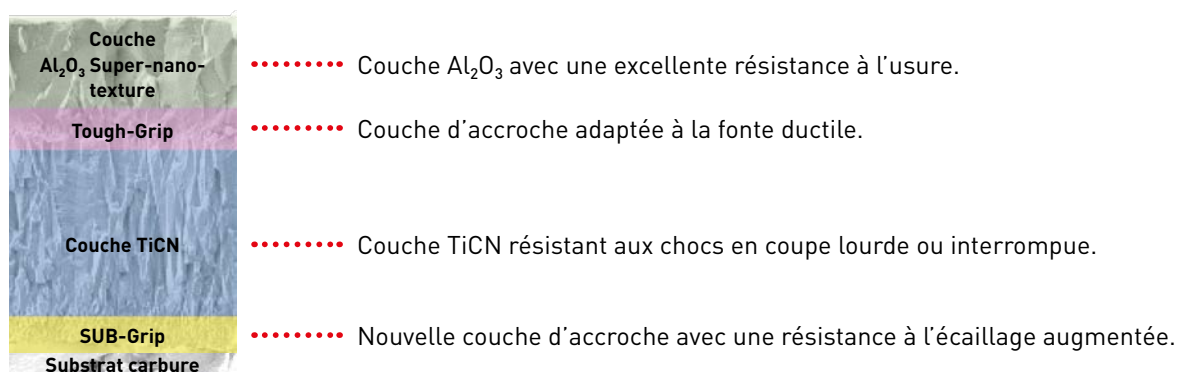

SÉRIE MC5100

SÉLECTION DE LA NUANCE

FONTE GRISE

MC5105 est la première préconisation pour l'usinage à grande vitesse de la fonte grise. Sélectionnez un brise-copeaux approprié pour optimiser la durée de vie de l'outil et réduire l'usure. MC5115 est préconisé pour les vitesses de 100–300 m / min et pour des conditions de coupe instables.

COUPE À HAUTE VITESSE 300–1000 M / MIN

MC5105 → Renforcez le brise-copeaux.

En cas d'écaillage

VITESSE DE COUPE 100–300 M / MIN

MC5115 → Augmentez l'acuité du brise-copeaux.

En cas d'usure

FONTE DUCTILE

MC5115 est la première préconisation pour la fonte ductile, y compris la fonte ductile traitée. Afin d'éviter la l'écaillage et l'usure, sélectionnez un brise-copeaux approprié. MC5125 est préconisé pour l'usinage au choc, les applications instables et le tournage lourd.

PREMIÈRE PRÉCONISATION

MC5115 → Renforcez le brise-copeaux.

En cas de l'écaillage

↑
En cas d'usure

TOURNAGE LOURD, TOURNAGE AU CHOC

MC5125 → Augmentez l'acuité du brise-copeaux.

En cas d'usure

FONTE GRISE

Semi-finition	Ébauche	Tournage lourd
MK MC5105	RK MC5105	MC5105
MK MC5105	RK MC5105	MC5105
MK MC5105 MC5115	RK MC5105 MC5115	MC5105 MC5115

FONTE DUCTILE

Finition	Semi-finition	Ébauche	Tournage lourd
LK MC5115	MK MC5115	RK MC5115	MC5115
LK MC5115	MK MC5115	RK MC5115	MC5115
LK MC5125	MK MC5125	RK MC5125	MC5125



SÉRIE MC5100

SYSTÈME BRISE-COPEAUX POUR LA FONTE

La gamme complète des nouveaux brise-copeaux a été appliquée avec les nouvelles nuances. Chaque brise-copeaux est parfaitement adapté à sa plage d'application.

SÉLECTION DU BRISE-COPEAUX EN FONCTION DE L'APPLICATION

Coupe continue, pièces sans croûte, finition

Acuité d'arête

PLAQUETTES NÉGATIVES



Brise-copeaux LK

Le témoin positif offre une coupe vive et et réduit les efforts de coupe.

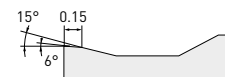

Brise-copeaux MA

Témoin positif pour une bonne acuité.

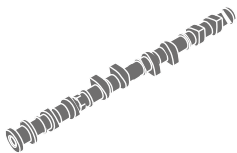

Brise-copeaux MK

Équilibre optimal entre acuité et résistance d'arête pour une utilisation polyvalente.

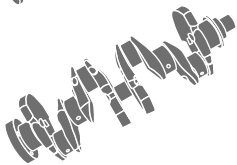
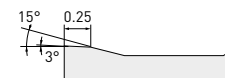

Brise-copeaux RK

Témoin large pour une grande résistance d'arête, pour l'usinage interrompu et l'enlèvement de croûtes.

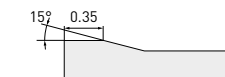

Brise-copeaux GK

Brise-copeaux d'ébauche polyvalent
Le témoin plat assure la résistance de l'arête de coupe.



Sans brise-copeaux

Plaquette plate pour une haute résistance d'arête.



Renfort d'arête

Coupe au choc, présence de croûtes, ébauche, tournage lourd



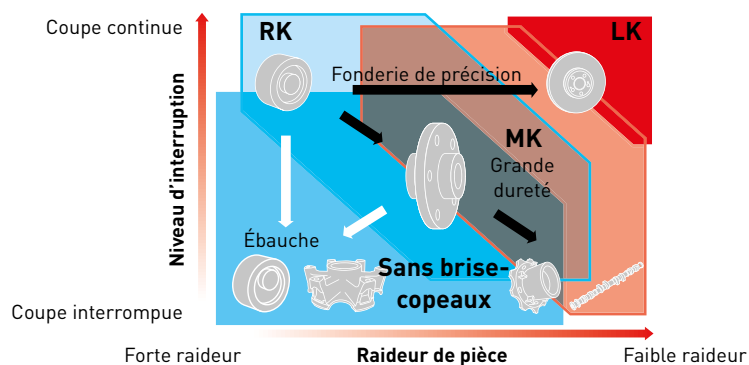





CARTE D'APPLICATION POUR LA FONTE



CNMG, CNMA

PLAQUETTES NÉGATIVES (À TROU)

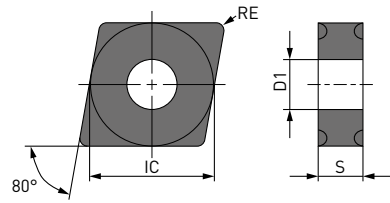
K
Classe M

Référence		MC5105	MC5115	MC5125	IC	S	RE	D1		Géométrie
CNMG120404-LK	L	●	★		12.7	4.76	0.4	5.16		
CNMG120408-LK	L	●	★		12.7	4.76	0.8	5.16		
CNMG120412-LK	L	●	★		12.7	4.76	1.2	5.16		
CNMG120404-MA	M	●	●		12.7	4.76	0.4	5.16		
CNMG120408-MA	M	●	●		12.7	4.76	0.8	5.16		
CNMG120412-MA	M	●	●		12.7	4.76	1.2	5.16		
CNMG120416-MA	M	●	★		12.7	4.76	1.6	5.16		
CNMG160608-MA	M	●	●		15.875	6.35	0.8	6.35		
CNMG160612-MA	M	●	●		15.875	6.35	1.2	6.35		
CNMG160616-MA	M	●	★		15.875	6.35	1.6	6.35		
CNMG120404-MK	M	●	●		12.7	4.76	0.4	5.16		
CNMG120408-MK	M	●	●		12.7	4.76	0.8	5.16		
CNMG120412-MK	M	●	●		12.7	4.76	1.2	5.16		
CNMG120416-MK	M	★	●		12.7	4.76	1.6	5.16		
CNMG160608-MK	M	★	●	★	15.875	6.35	0.8	6.35		
CNMG160612-MK	M	●	●		15.875	6.35	1.2	6.35		
CNMG160616-MK	M	●	●	★	15.875	6.35	1.6	6.35		
CNMG190612-MK	M	★			19.05	6.35	1.2	7.93		
CNMG190616-MK	M	★			19.05	6.35	1.6	7.93		
CNMG120404-GK	M	●	●		12.7	4.76	0.4	5.16		
CNMG120408-GK	M	●	●		12.7	4.76	0.8	5.16		
CNMG120412-GK	M	●	●		12.7	4.76	1.2	5.16		
CNMG120416-GK	M	●	★		12.7	4.76	1.6	5.16		
CNMG160612-GK	M	●	★		15.875	6.35	1.2	6.35		
CNMG160616-GK	M	●	★		15.875	6.35	1.6	6.35		
CNMG120408-RK	R	●	●		12.7	4.76	0.8	5.16		
CNMG120412-RK	R	●	●		12.7	4.76	1.2	5.16		
CNMG120416-RK	R	●	●		12.7	4.76	1.6	5.16		
CNMG160608-RK	R	★	●	★	15.875	6.35	0.8	6.35		
CNMG160612-RK	R	●	●		15.875	6.35	1.2	6.35		
CNMG160616-RK	R	●	●		15.875	6.35	1.6	6.35		
CNMG190612-RK	R	★			19.05	6.35	1.2	7.93		
CNMG190616-RK	R	★			19.05	6.35	1.6	7.93		
CNMA120404	R	●	●		12.7	4.76	0.4	5.16		
CNMA120408	R	●	●		12.7	4.76	0.8	5.16		
CNMA120412	R	●	●		12.7	4.76	1.2	5.16		
CNMA120416	R	●	●		12.7	4.76	1.6	5.16		
CNMA160612	R	●	●		15.875	6.35	1.2	6.35		
CNMA160616	R	●	●		15.875	6.35	1.6	6.35		
CNMA190612	R	●			19.05	6.35	1.2	7.93		
CNMA190616	R	●			19.05	6.35	1.6	7.93		
CNMA190624	R	●			19.05	6.35	2.4	7.93		

(Conditionnement par quantité 10)





● : Article stocké. ★ : Article stocké au Japon.

DNMG, DNMA

PLAQUETTES NÉGATIVES (À TROU)

K
Classe M

Référence			IC	S	RE	D1		Géométrie
DNMG110408-LK	L	● ★	9.525	4.76	0.8	3.81		
DNMG150404-LK	L	● ★	12.7	4.76	0.4	5.16		
DNMG150408-LK	L	● ★	12.7	4.76	0.8	5.16		
DNMG150412-LK	L	★ ★	12.7	4.76	1.2	5.16		
DNMG150604-LK	L	● ★	12.7	6.35	0.4	5.16		
DNMG150608-LK	L	● ★	12.7	6.35	0.8	5.16		
DNMG150612-LK	L	● ★	12.7	6.35	1.2	5.16		
DNMG150404-MA	M	● ★	12.7	4.76	0.4	5.16		
DNMG150408-MA	M	● ●	12.7	4.76	0.8	5.16		
DNMG150412-MA	M	★ ★	12.7	4.76	1.2	5.16		
DNMG150604-MA	M	● ★	12.7	6.35	0.4	5.16		
DNMG150608-MA	M	● ●	12.7	6.35	0.8	5.16		
DNMG150612-MA	M	● ●	12.7	6.35	1.2	5.16		
DNMG110408-MK	M	★ ● ●	9.525	4.76	0.8	3.81		
DNMG150404-MK	M	● ● ★	12.7	4.76	0.4	5.16		
DNMG150408-MK	M	● ● ●	12.7	4.76	0.8	5.16		
DNMG150412-MK	M	● ● ★	12.7	4.76	1.2	5.16		
DNMG150604-MK	M	● ● ●	12.7	6.35	0.4	5.16		
DNMG150608-MK	M	● ● ●	12.7	6.35	0.8	5.16		
DNMG150612-MK	M	● ● ●	12.7	6.35	1.2	5.16		
DNMG150404-GK	M	● ★	12.7	4.76	0.4	5.16		
DNMG150408-GK	M	● ★	12.7	4.76	0.8	5.16		
DNMG150412-GK	M	● ★	12.7	4.76	1.2	5.16		
DNMG150604-GK	M	● ★	12.7	6.35	0.4	5.16		
DNMG150608-GK	M	● ●	12.7	6.35	0.8	5.16		
DNMG150612-GK	M	● ★	12.7	6.35	1.2	5.16		
DNMG150408-RK	R	● ● ★	12.7	4.76	0.8	5.16		
DNMG150412-RK	R	● ● ★	12.7	4.76	1.2	5.16		
DNMG150608-RK	R	● ● ●	12.7	6.35	0.8	5.16		
DNMG150612-RK	R	● ● ●	12.7	6.35	1.2	5.16		
DNMA150404	R	● ● ★	12.7	4.76	0.4	5.16		
DNMA150408	R	● ● ★	12.7	4.76	0.8	5.16		
DNMA150412	R	● ● ★	12.7	4.76	1.2	5.16		
DNMA150604	R	● ● ★	12.7	6.35	0.4	5.16		
DNMA150608	R	● ● ●	12.7	6.35	0.8	5.16		
DNMA150612	R	● ● ●	12.7	6.35	1.2	5.16		

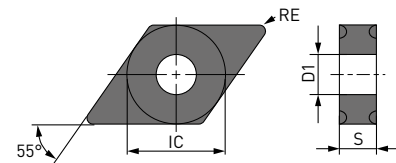

(Conditionnement par quantité 10)















SNMG, SNMA

PLAQUETTES NÉGATIVES (À TROU)

K

Classe M

Référence		MC5105	MC5115	MC5125	IC	S	RE	D1		Géométrie
SNMG120408-LK	L		●	★	12.7	4.76	0.8	5.16		
SNMG120412-LK	L		●	★	12.7	4.76	1.2	5.16		
SNMG120404-MA	M		●	★	12.7	4.76	0.4	5.16		
SNMG120408-MA	M		●	★	12.7	4.76	0.8	5.16		
SNMG120412-MA	M		●	★	12.7	4.76	1.2	5.16		
SNMG120416-MA	M		●	★	12.7	4.76	1.6	5.16		
SNMG150612-MA	M		●	●	15.875	6.35	1.2	6.35		
SNMG120408-MK	M	●	●	★	12.7	4.76	0.8	5.16		
SNMG120412-MK	M	●	●	★	12.7	4.76	1.2	5.16		
SNMG120416-MK	M	★	●	★	12.7	4.76	1.6	5.16		
SNMG150612-MK	M	★	●	★	15.875	6.35	1.2	6.35		
SNMG150616-MK	M	★	●	★	15.875	6.35	1.6	6.35		
SNMG190612-MK	M	★			19.05	6.35	1.2	7.93		
SNMG190616-MK	M	★			19.05	6.35	1.6	7.93		
SNMG120404-GK	M		●	★	12.7	4.76	0.4	5.16		
SNMG120408-GK	M		●	●	12.7	4.76	0.8	5.16		
SNMG120412-GK	M		●	●	12.7	4.76	1.2	5.16		
SNMG120416-GK	M		●	★	12.7	4.76	1.6	5.16		
SNMG150612-GK	M		●	★	15.875	6.35	1.2	6.35		
SNMG120408-RK	R	●	●	★	12.7	4.76	0.8	5.16		
SNMG120412-RK	R	●	●	●	12.7	4.76	1.2	5.16		
SNMG120416-RK	R	●	●	★	12.7	4.76	1.6	5.16		
SNMG150612-RK	R	★	●	★	15.875	6.35	1.2	6.35		
SNMG150616-RK	R	★	●	★	15.875	6.35	1.6	6.35		
SNMG190612-RK	R	★			19.05	6.35	1.2	7.93		
SNMG190616-RK	R	★			19.05	6.35	1.6	7.93		
SNMA090308	R	★	★	★	9.525	3.18	0.8	3.81		
SNMA120408	R	●	●	★	12.7	4.76	0.8	5.16		
SNMA120412	R	●	●	●	12.7	4.76	1.2	5.16		
SNMA120416	R	●	●	●	12.7	4.76	1.6	5.16		
SNMA150612	R	●	●	★	15.875	6.35	1.2	6.35		
SNMA150616	R	●	●	●	15.875	6.35	1.6	6.35		
SNMA190612	R	●			19.05	6.35	1.2	7.93		
SNMA190616	R	●			19.05	6.35	1.6	7.93		

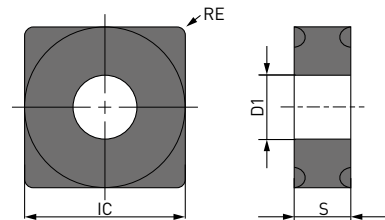









(Conditionnement par quantité 10)



TNMG, TNMA

PLAQUETTES NÉGATIVES (À TROU)

K
Classe M

Référence		MC5105	MC5115	MC5125	IC	S	RE	D1		Géométrie
TNMG160404-LK	L	●	★		9.525	4.76	0.4	3.81		
TNMG160408-LK	L	●	★		9.525	4.76	0.8	3.81		
TNMG160412-LK	L	●	★		9.525	4.76	1.2	3.81		
TNMG160404-MA	M	●	★		9.525	4.76	0.4	3.81		
TNMG160408-MA	M	●	●		9.525	4.76	0.8	3.81		
TNMG160412-MA	M	●	●		9.525	4.76	1.2	3.81		
TNMG160416-MA	M	●	★		9.525	4.76	1.6	3.81		
TNMG220408-MA	M		★	★	12.7	4.76	0.8	5.16		
TNMG220412-MA	M		★	★	12.7	4.76	1.2	5.16		
TNMG220416-MA	M	●	●		12.7	4.76	1.6	5.16		
TNMG160404-MK	M	●	●	★	9.525	4.76	0.4	3.81		
TNMG160408-MK	M	●	●	●	9.525	4.76	0.8	3.81		
TNMG160412-MK	M	●	●	★	9.525	4.76	1.2	3.81		
TNMG220408-MK	M	★	●	★	12.7	4.76	0.8	5.16		
TNMG220412-MK	M	★	★	★	12.7	4.76	1.2	5.16		
TNMG220416-MK	M	★	★	★	12.7	4.76	1.6	5.16		
TNMG160404-GK	M	●	★		9.525	4.76	0.4	3.81		
TNMG160408-GK	M	●	●		9.525	4.76	0.8	3.81		
TNMG160412-GK	M	●	★		9.525	4.76	1.2	3.81		
TNMG160416-GK	M	●	★		9.525	4.76	1.6	3.81		
TNMG220408-GK	M	●	★		12.7	4.76	0.8	5.16		
TNMG220412-GK	M		★	★	12.7	4.76	1.2	5.16		
TNMG160408-RK	R	●	●	●	9.525	4.76	0.8	3.81		
TNMG160412-RK	R	●	●	●	9.525	4.76	1.2	3.81		
TNMG160416-RK	R	●	●	★	9.525	4.76	1.6	3.81		
TNMG220408-RK	R	●	●	★	12.7	4.76	0.8	5.16		
TNMG220412-RK	R	●	●	★	12.7	4.76	1.2	5.16		
TNMG220416-RK	R	●	●	★	12.7	4.76	1.6	5.16		
TNMA160404	R	●	●	★	9.525	4.76	0.4	3.81		
TNMA160408	R	●	●	●	9.525	4.76	0.8	3.81		
TNMA160412	R	●	●	●	9.525	4.76	1.2	3.81		
TNMA160416	R	●	●	●	9.525	4.76	1.6	3.81		
TNMA160420	R	★	★	★	9.525	4.76	2.0	3.81		
TNMA220408	R	●	●	★	12.7	4.76	0.8	5.16		
TNMA220412	R	●	●	★	12.7	4.76	1.2	5.16		
TNMA220416	R	●	●	●	12.7	4.76	1.6	5.16		

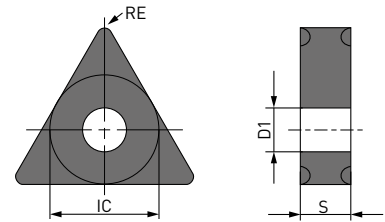

(Conditionnement par quantité 10)













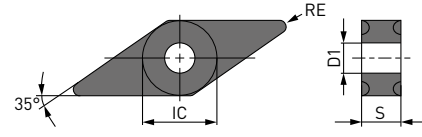

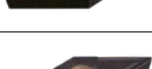









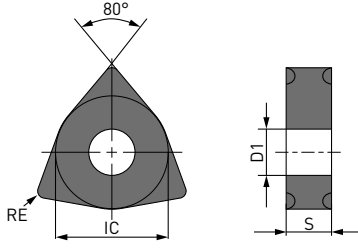

VNMG, WNMG, WNMA

PLAQUETTES NÉGATIVES (À TROU)

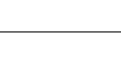
K

Classe M

Référence				MC5105	MC5115	MC5125	IC	S	RE	D1		Géométrie
	L	M	R									
VNMG160404-LK	L			●	★		9.525	4.76	0.4	3.81		
VNMG160408-LK	L			●	★		9.525	4.76	0.8	3.81		
VNMG160404-MA	M			●	★		9.525	4.76	0.4	3.81		
VNMG160408-MA	M			●	★		9.525	4.76	0.8	3.81		
VNMG160404-MK	M	●	●	●	★		9.525	4.76	0.4	3.81		
VNMG160408-MK	M	●	●	●	★		9.525	4.76	0.8	3.81		
VNMG160412-MK	M	●	●	●	★		9.525	4.76	1.2	3.81		
VNMG160404-GK	M			●	★		9.525	4.76	0.4	3.81		
VNMG160408-GK	M			●	★		9.525	4.76	0.8	3.81		
VNMG160412-GK	M			●	★		9.525	4.76	1.2	3.81		
VNMA160404	R	★	●	★			9.525	4.76	0.4	3.81		
VNMA160408	R	★	●	●			9.525	4.76	0.8	3.81		
VNMA160412	R	★	●	★			9.525	4.76	1.2	3.81		
WNMG080404-LK	L			●	★		12.7	4.76	0.4	5.16		
WNMG080408-LK	L			●	★		12.7	4.76	0.8	5.16		
WNMG080412-LK	L			●	★		12.7	4.76	1.2	5.16		
WNMG060408-MA	M			●	●		9.525	4.76	0.8	3.81		
WNMG060412-MA	M			●	★		9.525	4.76	1.2	3.81		
WNMG080404-MA	M			●	★		12.7	4.76	0.4	5.16		
WNMG080408-MA	M			●	●		12.7	4.76	0.8	5.16		
WNMG080412-MA	M			●	●		12.7	4.76	1.2	5.16		
WNMG080416-MA	M			●	★		12.7	4.76	1.6	5.16		
WNMG080404-MK	M	●	●	●	★		12.7	4.76	0.4	5.16		
WNMG080408-MK	M	●	●	●	★		12.7	4.76	0.8	5.16		
WNMG080412-MK	M	●	●	●	★		12.7	4.76	1.2	5.16		
WNMG080416-MK	M	★	●	★			12.7	4.76	1.6	5.16		
WNMG060404-GK	M			★	●		9.525	4.76	0.4	3.81		
WNMG060408-GK	M			●	★		9.525	4.76	0.8	3.81		
WNMG080404-GK	M			●	★		12.7	4.76	0.4	5.16		
WNMG080408-GK	M			●	●		12.7	4.76	0.8	5.16		
WNMG080412-GK	M			●	●		12.7	4.76	1.2	5.16		
WNMG080416-GK	M			●	★		12.7	4.76	1.6	5.16		
WNMG080408-RK	R	●	●	●	●		12.7	4.76	0.8	5.16		
WNMG080412-RK	R	●	●	●	●		12.7	4.76	1.2	5.16		
WNMG080416-RK	R	●	●	●	●		12.7	4.76	1.6	5.16		
WNMA060408	R	★	●	★			9.525	4.76	0.8	3.81		
WNMA060412	R	★	●	★			9.525	4.76	1.2	3.81		
WNMA080404	R	●	●	★			12.7	4.76	0.4	5.16		
WNMA080408	R	●	●	●			12.7	4.76	0.8	5.16		
WNMA080412	R	●	●	●			12.7	4.76	1.2	5.16		
WNMA080416	R	●	●	★			12.7	4.76	1.6	5.16		

(Conditionnement par quantité 10)







79 

CNMN, SNMN, TNMN

PLAQUETTES NÉGATIVES (SANS TROU)

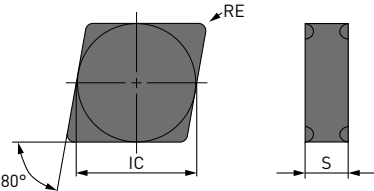

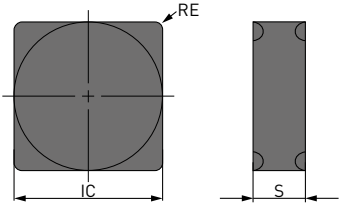
K

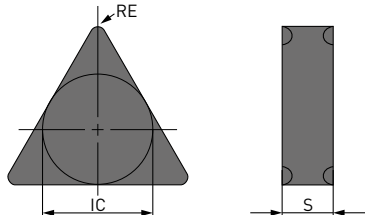
Classe M

Référence		MC5105	MC5115	MC5125	IC	S	RE	D1		Géométrie
CNMN120408	R	★	●	★	12.7	4.76	0.8	R		
CNMN120412	R	★	●	★	12.7	4.76	1.2	R		
CNMN120416	R	★	●	★	12.7	4.76	1.6	R		
SNMN120408	R	★	●	★	12.7	4.76	0.8	R		
SNMN120412	R	★	●	●	12.7	4.76	1.2	R		
SNMN120416	R	★	★	★	12.7	4.76	1.6	R		
SNMN120420	R	★	●	★	12.7	4.76	2.0	R		
TNMN160408	R	★	●	★	9.525	4.76	0.8	R		
TNMN160412	R	★	●	★	9.525	4.76	1.2	R		
TNMN160416	R	★	★	●	9.525	4.76	1.6	R		
TNMN160420	R	★	●	★	9.525	4.76	2.0	R		

CCMT, DCMT

PLAQUETTES POSITIVES 7° (À TROU)

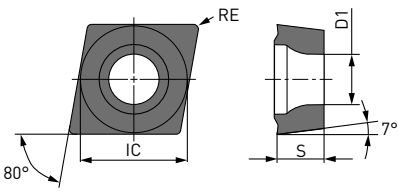
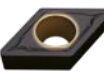
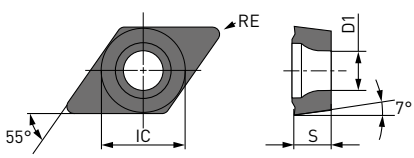
Référence		MC5105	MC5115	MC5125	IC	S	RE	D1		Géométrie
CCMT060204-MK	M		●	●	6.35	2.38	0.4	2.8		
CCMT060208-MK	M		●	★	6.35	2.38	0.8	2.8		
CCMT09T304-MK	M		●	●	9.525	3.97	0.4	4.4		
CCMT09T308-MK	M		●	●	9.525	3.97	0.8	4.4		
CCMT120404-MK	M		●	★	12.7	4.76	0.4	5.5		
CCMT120408-MK	M		●	●	12.7	4.76	0.8	5.5		
CCMT120412-MK	M		●	★	12.7	4.76	1.2	5.5		
DCMT070204-MK	M		●	★	6.35	2.38	0.4	2.8		
DCMT070208-MK	M		●	★	6.35	2.38	0.8	2.8		
DCMT11T304-MK	M		●	●	9.525	3.97	0.4	4.4		
DCMT11T308-MK	M		●	●	9.525	3.97	0.8	4.4		
DCMT150404-MK	M		●	★	12.7	4.76	0.4	5.5		
DCMT150408-MK	M		●	★	12.7	4.76	0.8	5.5		

(Conditionnement par quantité 10)

SÉRIE MC5100

CONDITIONS DE COUPE RECOMMANDÉES

PLAQUETTES NÉGATIVES

Matière	Dureté	Conditions d'usinage	Nuance	Vc
K Fonte grise	< 350MPa	●	MC5105	230-700
		●	MC5105	210-640
		⊕	MC5105	195-605
	< 450MPa	⊕	MC5115	190-350
		●	MC5115	195-365
		●	MC5115	180-330
Fonte ductile	< 800MPa	⊕	MC5125	95-190
		●	MC5115	175-325
		●	MC5115	160-295
		⊕	MC5125	85-170

Application		f	ap
Finition	LK	0.10-0.50	0.50-2.50
Semi-finition	MK	0.20-0.55	0.50-4.00
Semi-finition	MA	0.20-0.50	0.30-4.00
Ébauche	GK	0.25-0.60	1.50-5.00
Ébauche	RK	0.20-0.60	1.50-6.00
Fonte grise	-	0.20-0.60	2.50-6.00

PLAQUETTES POSITIVES 7°

Matière	Dureté	Conditions d'usinage	Nuance	Vc
K Fonte ductile	< 450MPa	●	MC5115	170-320
		●	MC5115	130-250
		⊕	MC5125	60-130
	< 800MPa	●	MC5115	125-240
		●	MC5115	105-200
		⊕	MC5125	55-115

Application	Brise-copeaux	f	ap
Semi-finition / alésage	MK	0.08-0.30	0.30-2.00

EXEMPLES D'APPLICATION

MC5105

RÉSISTANCE À L'USURE EN USINAGE DE FT30 À UNE VITESSE DE COUPE DE 1000 M / MIN

Adhésion du revêtement:

Mesure d'adhésion par test de rayure qui enregistre la force nécessaire pour arracher les couches de revêtement.

Matière	Ft30
Plaquette	CNMA120412
Vc (m / min)	1.000
f (mm / tr)	0.3
ap (mm)	2.0
Arrosage	Usinage à sec

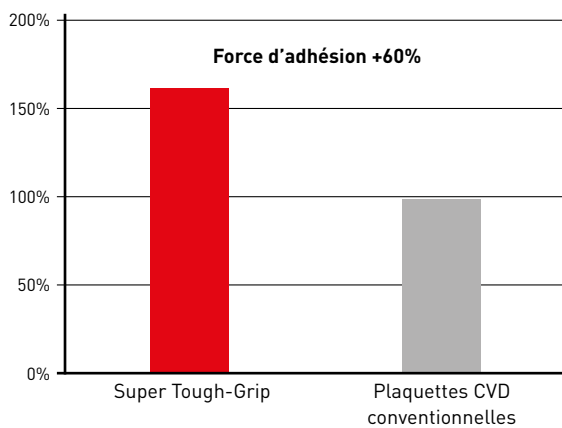

Après 4 min d'usinage



MC5105

Conventionnel A

Conventionnel B

Après 23 min

Image finale
Après 18 min

Après 23 min



MC5105

Conventionnel A

Conventionnel B

MC5115

RÉSISTANCE À L'USURE EN COUPE CONTINUE DE FGS700

Matière	FGS700
Outil	CNMA120412
Vc (m / min)	250
f (mm / tr)	0.3
ap (mm)	2.0
Arrosage	Huile soluble

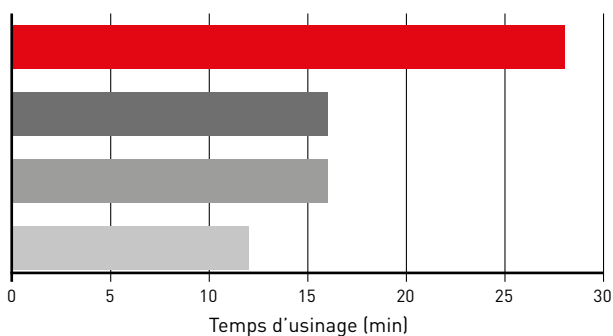

Après 16 min d'usinage

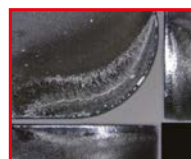

MC5115

Après 12 min d'usinage

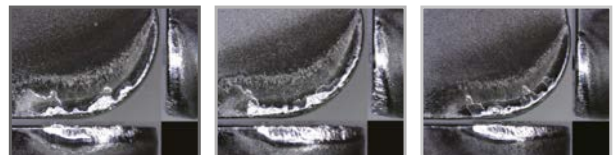

Conventionnel A

Conventionnel B

Conventionnel C

EXEMPLES D'APPLICATION

MC5125

RÉSISTANCE À L'ÉCAILLAGE APRÈS 10 PASSES DE COUPE INTERROMPUE DE FGS700

Matière	FGS700
Plaquette	CNMA120412
Vc (m / min)	250
f (mm / tr)	0.3
ap (mm)	2.0
Arrosage	Huile soluble

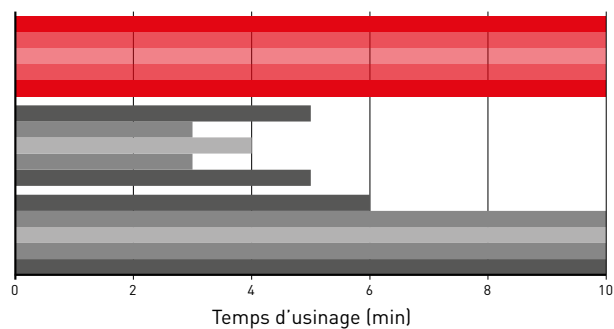

Après 10 passes



MC5125

Après 5 passes



Conventionnel A

Après 10 passes



Conventionnel B



VFR

NOUVELLE GÉNÉRATION DE FRAISES
POUR L'USINAGE DES ACIERS TRAITÉS



En savoir plus...

B231

www.mhg-mediastore.net



DIA EDGE



FRAISES POUR L'USINAGE DES ACIERS TRAITÉS

NOUVELLE TECHNOLOGIE DE REVÊTEMENT

Le nouveau revêtement PVD multicouches AlCrSiN offre une meilleure résistance à l'oxydation, un meilleur glissement, une résistance à l'usure supérieure et une meilleure adhésion au substrat. Idéal pour le fraisage de matières extrêmement dures jusqu'à 70 HRC.

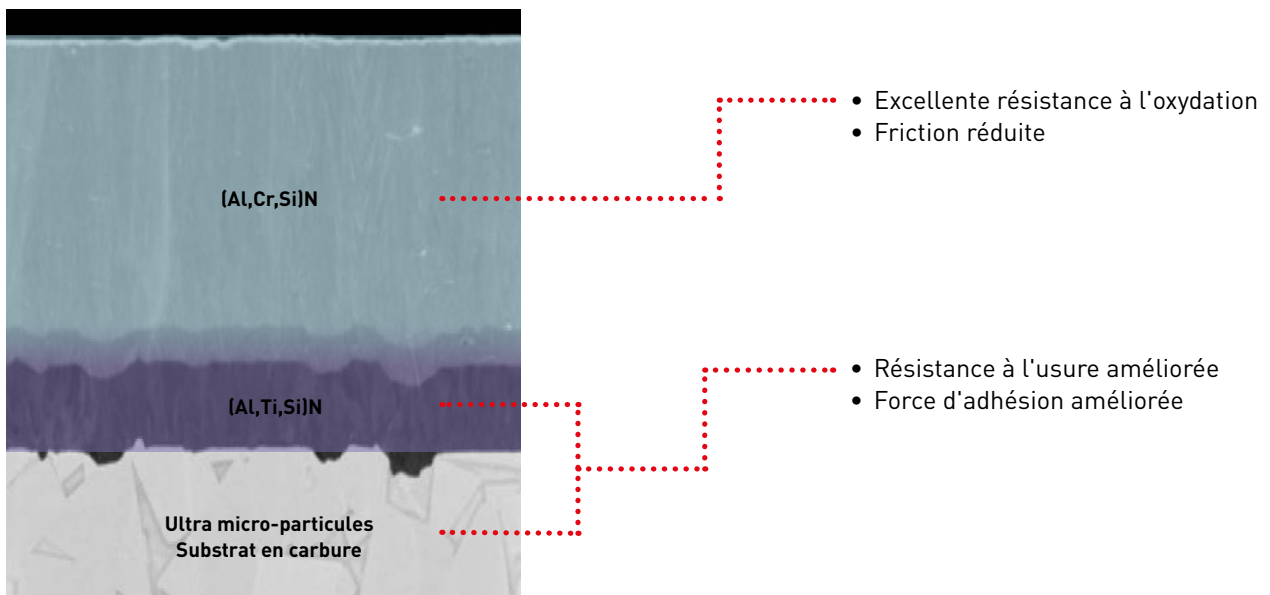

VFR4MB

POUR UNE PLUS GRANDE PRODUCTIVITÉ EN FINITION

TEMPS D'USINAGE RÉDUITS TOUT EN OBTENANT D'EXCELLENTS ÉTATS DE SURFACE



CONCEPTION DE LA FRAISE HÉMISPÉRIQUE À 4 DENTS

Les 4 dents s'étendent du centre outil à la périphérie. Le nombre de dents indépendant de l'angle d'inclinaison permet d'obtenir de fortes vitesses d'avance indépendamment de l'inclinaison et évite de modifier les conditions de coupe sur une même opération.



ANGLE D'INCLINAISON

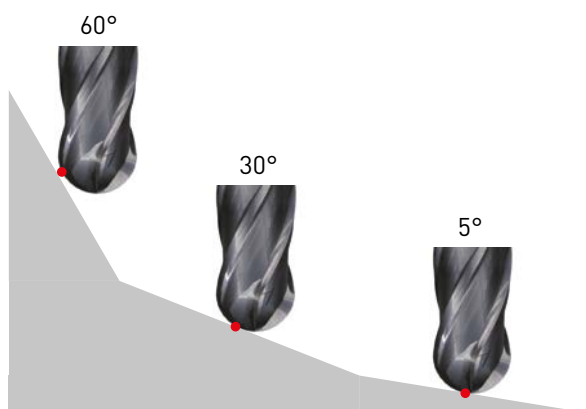

CHOIX DU NOMBRE DE DENTS

Les fraises à 2 dents ont généralement une poche à copeaux plus grande et sont mieux adaptées à l'ébauches et aux profondeurs de passe élevées qui produisent un plus grand volume de copeaux.

Les fraises à 4 dents permettent d'augmenter la productivité et de réduire l'usure dans les opérations de finition à des faibles profondeurs de passe. La géométrie à 4 dents est préconisée pour les matières de très haute dureté usinées à des profondeurs de passe réduites.

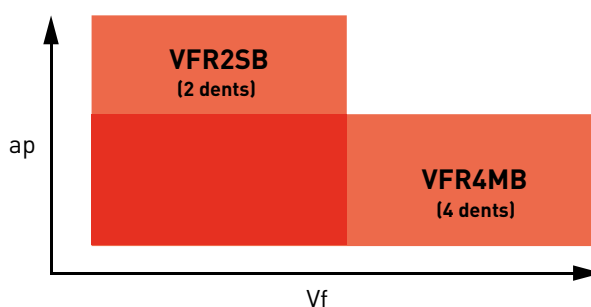

VFR4MB

PERFORMANCES D'USINAGE

COMPARAISON D'ÉTAT DE SURFACE - USINAGE HSS 6-5-3 (62 HRC)

Un outil à 4 dents permet d'atteindre une plus grande productivité qu'un outil à 2 dents. Lorsqu'il est utilisé à la même vitesse d'avance table qu'une fraise 2 dents, l'état de surface est amélioré.

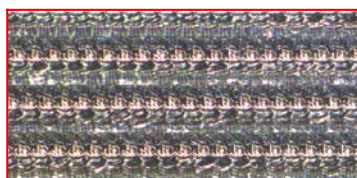

VFR4MB

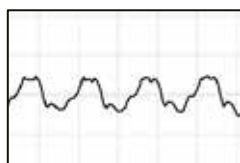

Ra: 0.27 / Rz: 1.01

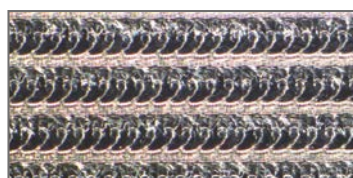

Produit conventionnel à 2 dents

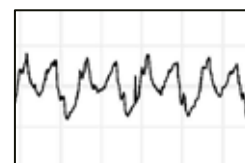

Ra: 0.32 / Rz: 1.62

Matière	HSS 6-5-3 (62 HRC)
Outil	VFR4MBR0400 / DC=8 mm
n (tr/min)	12000
f (mm/min)	3600
ap (mm)	0.2
ae (mm)	0.8
Porte-à-faux (mm)	20
Arrosage	Soufflage d'air Fraisage en avalant

COMPARAISON DE LA RÉSISTANCE À L'USURE - USINAGE PMHS 7-7-7-11 (69 HRC)

Les fraises IMPACT MIRACLE REVOLUTION démontrent une excellente résistance à l'usure même en l'usinage de matériaux de très grande dureté.

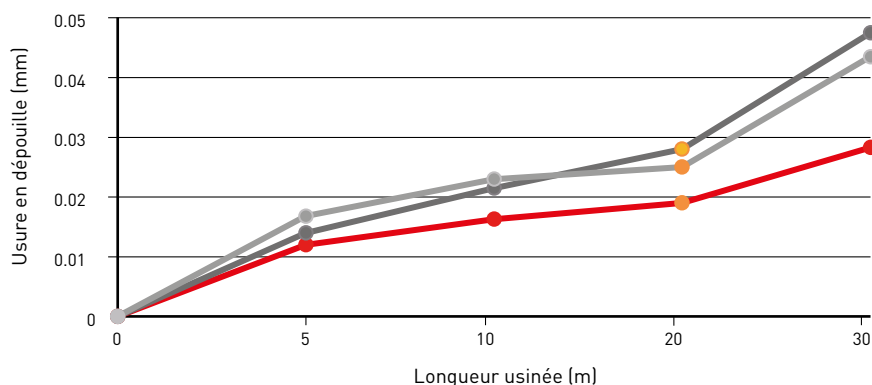

Matière	PMHS 7-7-7-11 (69 HRC)
Outil	VFR4MBR0100 / DC=2mm
n (tr/min)	16000
f (mm/min)	1200
ap (mm)	0.06
ae (mm)	0.2
Porte-à-faux (mm)	17
Arrosage	Soufflage d'air Fraisage en avalant
Machine	CU vertical

Usure après 20 m d'usinage

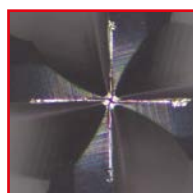

VFR4MB

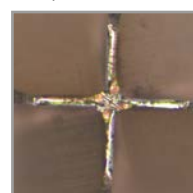

Conventionnel A



Conventionnel B

VFR4MB



FRAISE HÉMISPHERIQUE, LONGUEUR DE COUPE MOYENNE, 4 DENTS

H



1

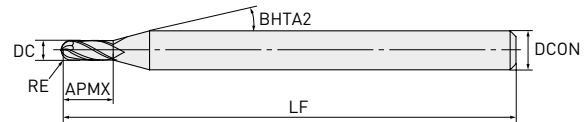

2

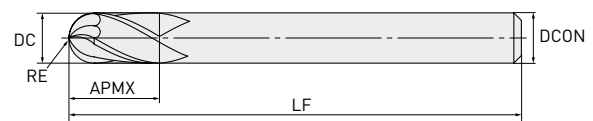

RE

±0.010



DCON = 6 8 ≤ DCON ≤ 10 DCON = 12

0	0	0
- 0.008	- 0.009	- 0.011

- Géométrie à 4 dents sur l'ensemble de la fraise pour une plus grande durée de vie et une productivité augmentée.

Référence	Stock	RE	DC	APMX	LF	BHTA2	DCON	ZEFP	Type
VFR4MBR0050	●	0.5	1	2.5	50	15	6	4	1
VFR4MBR0100	●	1	2	6	60	15	6	4	1
VFR4MBR0150	●	1.5	3	8	70	15	6	4	1
VFR4MBR0200	●	2	4	8	70	15	6	4	1
VFR4MBR0250	●	2.5	5	12	80	15	6	4	1
VFR4MBR0300	●	3	6	12	80	—	6	4	2
VFR4MBR0400	●	4	8	14	90	—	8	4	2
VFR4MBR0500	●	5	10	18	100	—	10	4	2
VFR4MBR0600	●	6	12	22	110	—	12	4	2

VFR4MB

CONDITIONS DE COUPE RECOMMANDÉES

Matière	RE	$\alpha \leq 15^\circ$		$\alpha > 15^\circ$		ap	ae
		n	f	n	f		
Acier traité (45-55 HRC)	0.5	40000	8000	40000	3800	0.06	0.10
	1.0	40000	9600	40000	5600	0.11	0.20
	1.5	40000	12000	32000	5600	0.13	0.30
	2.0	32000	11000	24000	4700	0.15	0.40
	2.5	25000	9000	19000	3800	0.20	0.50
	3.0	21000	8400	15000	3400	0.25	0.60
	4.0	16000	6400	12000	2600	0.30	0.80
	5.0	13000	5200	9600	2200	0.50	1.00
	6.0	9000	3600	7200	1700	0.50	1.20
H Acier traité (55-65 HRC)	0.5	40000	5600	40000	3100	0.05	0.10
	1.0	40000	8000	28000	3100	0.10	0.20
	1.5	32000	7700	19000	2900	0.12	0.30
	2.0	24000	6200	14000	2500	0.13	0.40
	2.5	19000	5300	12000	2200	0.15	0.50
	3.0	16000	4800	9600	2000	0.20	0.60
	4.0	12000	3600	7200	1600	0.20	0.80
	5.0	10000	3200	5800	1300	0.20	1.00
	6.0	7000	2200	4300	940	0.30	1.20
Acier traité (65-70 HRC)	0.5	40000	4700	32000	1700	0.03	0.10
	1.0	24000	5000	16000	1200	0.06	0.20
	1.5	16000	4200	11000	1100	0.07	0.30
	2.0	12000	3100	8000	1000	0.08	0.40
	2.5	9600	2700	6000	780	0.08	0.50
	3.0	8000	2300	5000	780	0.09	0.60
	4.0	6000	1900	4000	620	0.09	0.80
	5.0	4800	1500	3000	550	0.10	1.00
	6.0	3600	1100	2200	400	0.10	1.20

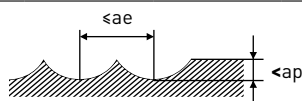

1. Dans la cas d'une faible profondeur de passe, il est possible d'augmenter les vitesses de rotation et d'avance.
Il est possible de réduire la vitesse d'avance pour obtenir de meilleurs états de surface.
2. En cas de faible raideur de la machine, d'un bridage instable ou de vibrations et de bruits, veuillez ajuster les vitesses de rotation et d'avance ainsi que la profondeur de passe.
3. α représente l'angle d'inclinaison de la surface usinée.

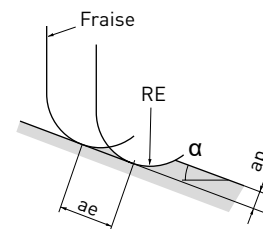

ae : pas de balayage

MS PLUS

SÉRIE DE FRAISES EN CARBURE MONOBLOC



En savoir plus...

B205

www.mhg-mediastore.net



MP3C

FRAISE À CHANFREINER, 3 DENTS

Grande durée de vie, précision, performance, polyvalence.

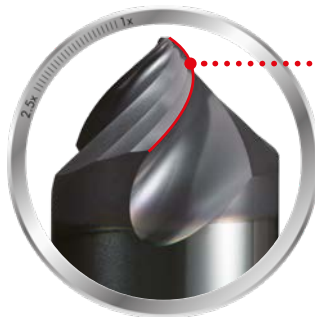

ACUITÉ

L'angle d'hélice optimisé assure une bonne acuité de l'outil, ce qui empêche la formation de bavures.

L'angle de chanfrein est de 45°.

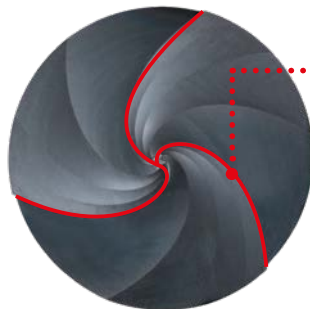

3 DENTS

La conception à 3 dents permet une grande vitesse d'avance et assure l'équilibre entre polyvalence et évacuation des copeaux.

Une excellente productivité est assurée.

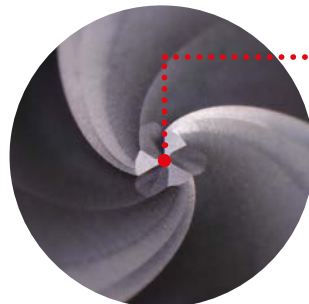

ARÊTES DE COUPE FRONTALES

Les arêtes de coupe frontales permettent d'utiliser la fraise en rainurage en V.



Rainurage en V

MP3C

CHANFREINAGE DE GRANDE EFFICACITÉ

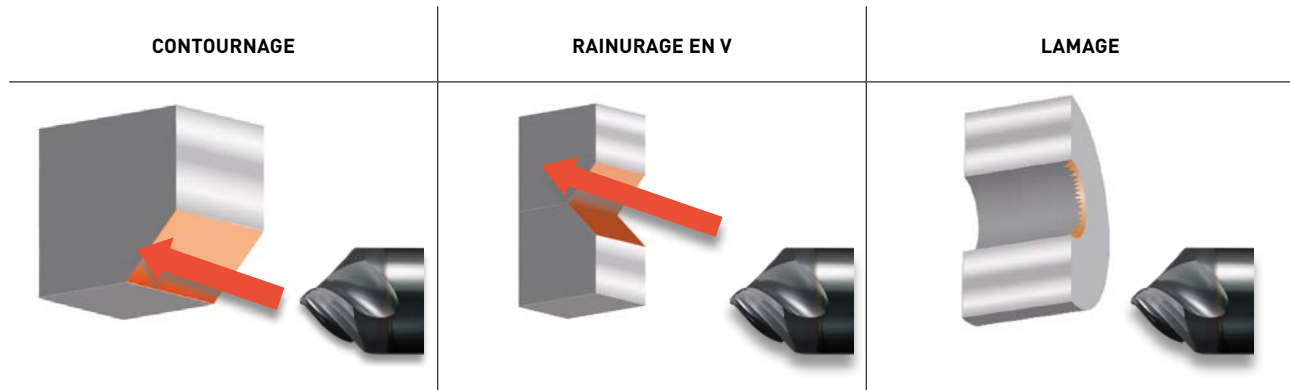

La géométrie à 3 dents permet une grande vitesse d'avance et une grande durée de vie.
Les dents hélicoïdales empêchent la formation de bavures.



1. Pour le pointage, nous préconisons les forets des types DLE.

Matière de la pièce	XC54
Outil	DC = Ø 6
Vc (m/min)	100
n (tr/min)	5300
fz (mm/dent)	0.03
ap (mm)	1.2
Porte-à-faux (mm)	18
Arrosage	Soufflage d'air

COMPARAISON DES BAVURES EN CHANFREINAGE DE XC54

<p>MP3C 3 dents hélicoïdales</p>		<p>Bon état de surface</p>
<p>Fraise conventionnelle 4 dents droites</p>		<p>Présence de bavures</p>
<p>Fraise conventionnelle 2 dents droites</p>		<p>Présence de bavures</p>

MS PLUS

SÉRIE DE FRAISES CARBURE MONOBLOC POUR UN USINAGE POLYVALENT



REVÊTEMENT MULTICOUCHE ALTiCrN (MS PLUS)

Une technologie de revêtement multicouches de type ALTiN et AlCrN.
Offrant la possibilité d'usiner d'une large gamme de matériaux de pièces à usiner.

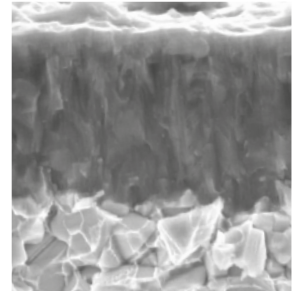

PROPRIÉTÉS DU REVÊTEMENT MULTICOUCHE (Al,Ti,Cr)N (MS PLUS)

	Revêtement multicouche (Al,Ti,Cr)N	(Al,Ti)N	(Al,Cr)N
Dureté (HV)	3200	2800	3100
Température d'oxydation (°C)	1100	800	1100
Adhésion (N)	100	80	80

PLAGE D'APPLICATION

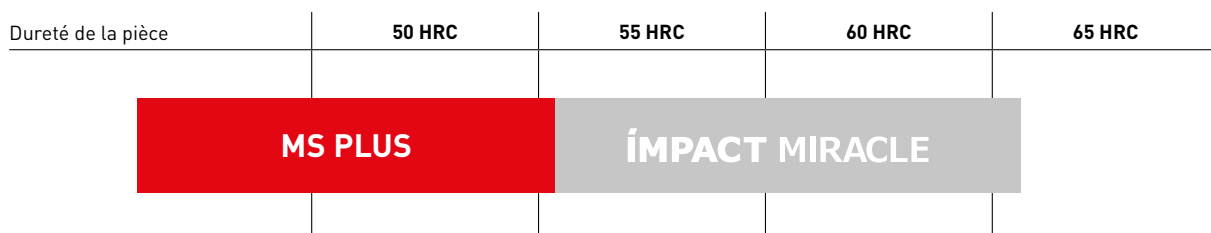

MS PLUS CONFÈRE À L'OUTIL UNE LONGUE DURÉE DE VIE SUR DES MATIÈRES ALLANT JUSQU'À 55 HRC.

Il est recommandé d'utiliser les fraises IMPACT MIRACLE pour les aciers d'une dureté supérieure à 55 HRC.

MP3C



FRAISE À CHANFREINER, 3 DENTS

P M S H

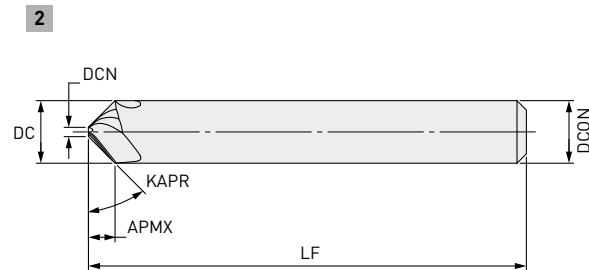
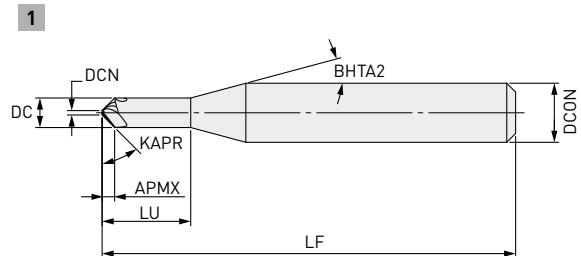

DCN

± 0.03



DCON=6 8<DCON<=10 DCON=12

0	0	0
-0.008	-0.009	-0.011

- L'angle d'hélice optimisé assure une grande acuité et empêche la formation de bavures.
- Les 3 dents permettent une grande productivité.

Références	Stock	DC	APMX	LU	LF	DCON	ZEFP	DCN	Type
MP3CD0200	●	2	0.85	6	50	6	3	0.3	1
MP3CD0400	●	4	1.85	12	50	6	3	0.3	1
MP3CD0600	●	6	2.85	—	50	6	3	0.3	2
MP3CD0800	●	8	3.8	—	60	8	3	0.4	2
MP3CD1000	●	10	4.75	—	70	10	3	0.5	2
MP3CD1200	●	12	5.75	—	75	12	3	0.5	2

MP3C

CONDITIONS DE COUPE RECOMMANDÉES

CHANFREINAGE (CONTOURNAGE ET LAMAGE)

Matière	DC	Vc	n	Vf	Contournage		Lamage	
					ap			
P Acier doux, Fonte ductile, Acier au carbone (C ≥ 0,55%)	2	100	16000	1400	≤ 0.6	≤ 0.4	≤ 0.6	≤ 0.4
	4	100	8000	720	≤ 1.2	≤ 0.8	≤ 0.6	≤ 0.8
	6	100	5300	480	≤ 1.8	≤ 1.2	≤ 0.6	≤ 1.2
	8	100	4000	360	≤ 2.4	≤ 1.6	≤ 0.6	≤ 1.6
	10	100	3200	290	≤ 2.5	≤ 2.0	≤ 0.6	≤ 2.0
	12	100	2700	240	≤ 2.5	≤ 2.4	≤ 0.6	≤ 2.4
	2	70	11000	890	≤ 0.6	≤ 0.4	≤ 0.6	≤ 0.4
	4	70	5600	450	≤ 1.2	≤ 0.8	≤ 0.6	≤ 0.8
	6	70	3700	300	≤ 1.8	≤ 1.2	≤ 0.6	≤ 1.2
	8	70	2800	230	≤ 2.4	≤ 1.6	≤ 0.6	≤ 1.6
M Inox austénitique, Alliage de titane	10	70	2200	180	≤ 2.5	≤ 2.0	≤ 0.6	≤ 2.0
	12	70	1900	150	≤ 2.5	≤ 2.4	≤ 0.6	≤ 2.4
	2	60	9500	680	≤ 0.6	≤ 0.4	≤ 0.6	≤ 0.4
	4	60	4800	350	≤ 1.2	≤ 0.8	≤ 0.6	≤ 0.8
	6	60	3200	230	≤ 1.8	≤ 1.2	≤ 0.6	≤ 1.2
	8	60	2400	170	≤ 2.4	≤ 1.6	≤ 0.6	≤ 1.6
S Acier traité (45-55 HRC)	10	60	1900	140	≤ 2.5	≤ 2.0	≤ 0.6	≤ 2.0
	12	60	1600	120	≤ 2.5	≤ 2.4	≤ 0.6	≤ 2.4
	2	50	8000	480	≤ 0.6	≤ 0.4	≤ 0.6	≤ 0.4
	4	50	4000	240	≤ 1.2	≤ 0.8	≤ 0.6	≤ 0.8
	6	50	2700	160	≤ 1.8	≤ 1.2	≤ 0.6	≤ 1.2
	8	50	2000	120	≤ 2.4	≤ 1.6	≤ 0.6	≤ 1.6
H	10	50	1600	96	≤ 2.5	≤ 2.0	≤ 0.6	≤ 2.0
	12	50	1300	78	≤ 2.5	≤ 2.4	≤ 0.6	≤ 2.4

1. Un arrosage à l'huile soluble est préconisé pour l'usinage des inox austénitiques.
2. En cas de faible profondeur de passe, il est possible d'augmenter les vitesses de rotation et d'avance.
3. En cas de faible raideurs de machine ou de la pièce, des vibrations peuvent apparaître.
Dans ce cas, veuillez ajuster les conditions de coupe.

MP3C

RAINURAGE EN V

Matière	DC	Vc	n	Vf	ap	
P Acier doux, Fonte ductile, Acier au carbone (C ≥ 0,55%)	2	80	13000	940	≤ 1.4	
	4	80	6400	460	≤ 2.8	
	6	80	4200	300	≤ 4.2	
	8	80	3200	230	≤ 5.6	
	10	80	2500	180	≤ 7.0	
	12	80	2100	150	≤ 8.4	
	Acier allié (38-45 HRC)	2	60	9500	620	≤ 1.4
		4	60	4800	310	≤ 2.8
		6	60	3200	210	≤ 4.2
		8	60	2400	160	≤ 5.6
		10	60	1900	120	≤ 7.0
		12	60	1600	100	≤ 8.4
M Inox austénitique, Alliage de titane	2	50	8000	460	≤ 1.4	
	4	50	4000	230	≤ 2.8	
	6	50	2700	160	≤ 4.2	
	8	50	2000	120	≤ 5.6	
	S	10	50	1600	92	≤ 7.0
		12	50	1300	75	≤ 8.4
H Acier traité (45-55 HRC)	2	40	6400	310	≤ 1.4	
	4	40	3200	150	≤ 2.8	
	6	40	2100	100	≤ 4.2	
	8	40	1600	77	≤ 5.6	
	10	40	1300	62	≤ 7.0	
	12	40	1100	53	≤ 8.4	

1. Un arrosage à l'huile soluble est préconisé pour l'usinage des inox austénitiques.
2. En cas de faible profondeur de passe, il est possible d'augmenter les vitesses de rotation et d'avance.
3. En cas de faible raideurs de machine ou de la pièce, des vibrations peuvent apparaître.
Dans ce cas, veuillez ajuster les conditions de coupe.

FMAX

FEED MAXIMUM

FRAISE À SURFACER POUR UNE FINITION DE PRECISION
HAUTEMENT EFFICACE



En savoir plus...

B216

www.mhg-mediastore.net



FMAX

SÉLECTION DU CORPS DE FRAISE

Type	Utilisation	Caractéristiques	DCON MS	Minimum			Maximum		
				DC	ZEFP	WT	DC	ZEFP	WT
FMAX	Fraise de finition à forte avance	Corps léger de grande raideur	mm	—	—	—	160	16	3.30
		Corps en acier allié et aluminium	mm	80	14	1.08	125	24	3.39
FMAX-LW	Finition à forte avance	Corps allégé	mm	100	10	1.06	125	14	1.44
	Machines à puissance réduite	Composite aluminium / acier allié	mm	100	16	1.11	125	20	1.48
FMAX-40/50/63	Finition à forte avance	Corps en acier allié	mm	40	4	0.24	63	10	0.67
	Petits diamètres		mm	40	6	0.23	63	12	0.66
NEW FMAX-MB	Environnements de faible raideur	Pas large	mm	50	4	0.38	125	6	3.81

NEW

FMAX-MB

En réduisant le nombre de dents, la finition à forte avance peut également être utilisée sur des machines ou pièces de faible raideur. Les coûts d'investissement sont réduits, tout en conservant la possibilité de régler les plaquettes.

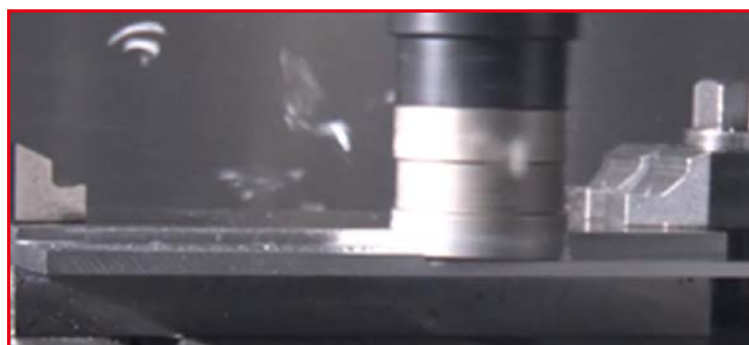

PLAQUETTE POUR APPLICATIONS SPÉCIFIQUES

PLAQUETTES FONTE

Les plaquettes CBN fonte permettent d'obtenir d'excellents états de surface. La longueur réduite du plat de planage empêche les vibrations. Plaquette non réaffûtable.

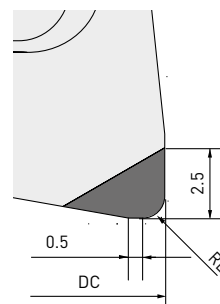

ARÊTE LONGUE

Lors de l'enlèvement de grandes épaisseurs, l'arête longue permet d'augmenter la profondeur de passe et donc de réduire le temps de cycle.

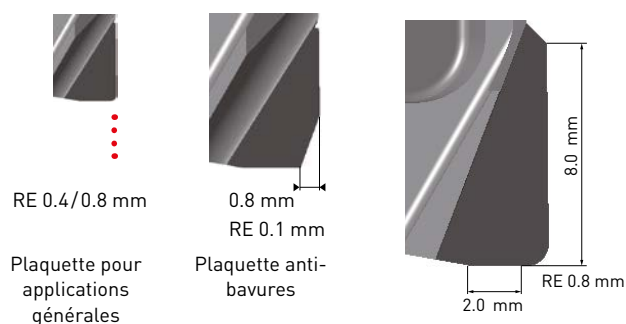

CONÇU POUR DES VITESSES ÉLEVÉES

Mécanisme de serrage type queue d'aronde anti-éjection.

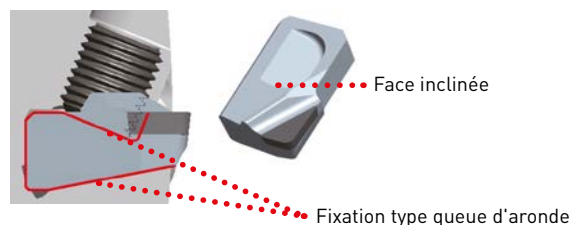

CONTRÔLE DU COPEAU OPTIMAL

Le brise-copeaux de la plaquette assure un contrôle du copeau optimal. L'arrosage interne permet une évacuation des copeaux performante. Le corps est compatible avec tous les porte-fraise du marché avec arrosage interne.

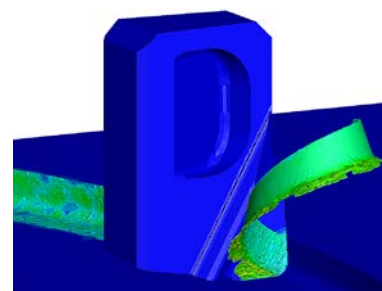

Représentation graphique



AVANTAGES

- Corps léger et très rigide
- Conçu pour des vitesses élevées
- Nuance PCD pour les alliages d'aluminium
- Nouvelle nuance CBN pour les fontes grises
- Haute précision

FMAX-MB



POUR UN ENVIRONNEMENT DE FAIBLE RAIDEUR



Corps à pas large

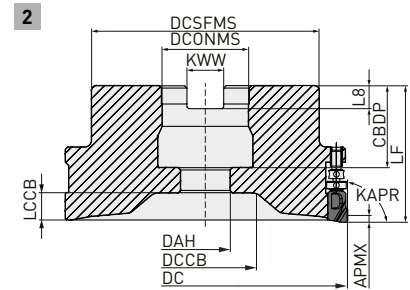
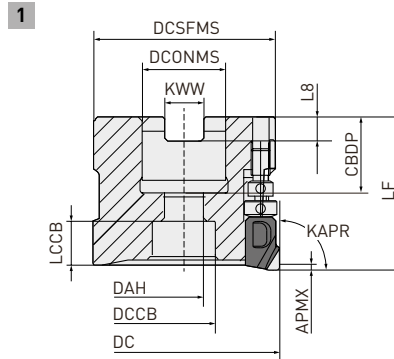

Outil à droite uniquement

ATTACHEMENT PAR ALÉSAGE

Référence	Stock	DC	DCONMS	LF	RPMX	WT	ZEFP*		Type
FMAX-050A04R	●	50	22	40	30000	0.38	4	○	1
FMAX-063A04R	●	63	22	40	30000	0.70	4	○	1
FMAX-080B04RMB	●	80	27	45	24500	1.12	4	○	2
FMAX-100B04RMB	●	100	32	50	22000	2.00	4	○	2
FMAX-125B06RMB	●	125	40	60	19600	3.81	6	○	2

* Veuillez consulter les tableaux de conditions de coupe pour la profondeur de passe maximale (APMX) et la profondeur de passe (ap) préconisée.



DIMENSIONS DE MONTAGE

Référence	CBDP	DAH	DCCB	DCFSMS	KWW	LCCB	L8	Type
FMAX-050A04R	20	11	17	47	10.4	12	6.3	1
FMAX-063A04R	20	11	17	60	10.4	12	6.3	1
FMAX-080B04RMB	24	13	30	55	12.4	11	7	2
FMAX-100B04RMB	32	17	39	75	14.4	10	8	2
FMAX-125B06RMB	36	22	45	100	16.4	12	9	2

PIÈCES DÉTACHÉES



Référence du Porte-outil

Référence du Porte-outil	Vis de fixation plaquette	Écrou d'ajustement micrométrique	Grande vis d'ajustement	Vis de fixation de fraise	Clé	Goupille de réglage
FMAX-040 ○○○○	TSS04505S	KSN2 KSN3	KSS2	HSC08030H	TKY10T	RKY25S
FMAX-050 ○○○○				HSC10030H		
FMAX-063 ○○○○				HSC10030H		
FMAX-080 ○○○○				HSCX12030H		
FMAX-100 ○○○○				HSCX16035H		
FMAX-125 ○○○○				HSCX20035H		

1. Couple de serrage TSS04505S = 3.5 Nm

2. Veuillez vous référer aux instructions du manuel fourni pour savoir comment placer la plaquette et régler le faux-rond.

PLAQUETTES





Référence	MD2030	MD220	MB4120	L	LE	W1	S	BS	RE	Figure
GOER1404PXFR2	●	●		14.0	5.0	9.0	4.2	2.0	0.4	
GOER1408PXFR2	●	●		14.0	5.0	9.0	4.2	2.0	0.8	
Usage général										
NP-GOEN1404PXSR05			★	14.0	2.5	9.0	4.2	0.5	0.4	
NP-GOEN1408PXSR05			★	14.0	2.5	9.0	4.2	0.5	0.8	
Finition fonte										
GOER1408PXFR2-8		★		14.0	8.0	9.0	4.2	2.0	0.8	
Arête longue										
GOER1401ZXFR2	●			14.0	5.0	9.0	4.2	2.0	0.1	
Antibavures										

1. Utilisées ensemble, les plaquettes universelles (RE = 0.4 mm, 0.8 mm) et les plaquettes antibavures n'offrent pas de résultats satisfaisants.

2. Il faut utiliser des plaquettes de la même géométrie pour toutes les dents.

FMAX

CONDITIONS DE COUPE RECOMMANDÉES

Matière	Dureté	Nuance	Vc	ae	ap	fz	Mode de coupe
K Fonte grise	≤350MPa	MB4120	1000 (700 – 1300)	≤0.8 DC	≤0.5	0.07 (0.05 – 0.15)	
				≤0.2 DC	≤3.0 (0.5 – 3.0)		
N Alliage d'aluminium	Si < 5 %	MD2030 MD220	2500 (2000 – 3000)	≤0.5 DC	≤2.5 (0.5 – 2.5)	0.08 (0.05 – 0.2)	
				≤0.8 DC	≤2.0 (0.5 – 2.0)		
				≤0.2 DC	≤3.0 (0.5 – 3.0)		
				≤0.5 DC	≤2.5 (0.5 – 2.5)		
	5 % ≤ Si ≤ 10 %	MD2030 MD220	2500 (2000 – 3000)	≤0.5 DC	≤2.5 (0.5 – 2.5)	0.08 (0.05 – 0.2)	
				≤0.8 DC	≤2.0 (0.5 – 2.0)		
				≤0.2 DC	≤3.0 (0.5 – 3.0)		
				≤0.5 DC	≤2.5 (0.5 – 2.5)		
10% < Si < 15 %	MD220 MD2030	600 (400 – 800)	≤0.5 DC	≤2.5 (0.5 – 2.5)	0.08 (0.05 – 0.2)		
			≤0.8 DC	≤2.0 (0.5 – 2.0)			
			≤0.2 DC	≤3.0 (0.5 – 3.0)			
			≤0.5 DC	≤2.5 (0.5 – 2.5)			
Si ≥ 15 %	MD220 MD2030	600 (400 – 800)	≤0.5 DC	≤2.5 (0.5 – 2.5)	0.08 (0.05 – 0.2)		
			≤0.8 DC	≤2.0 (0.5 – 2.0)			

1. Veuillez ajuster la profondeur de passe ap en fonction de l'engagement ae.

2. Lors de l'utilisation de plaquettes à arête longue, veuillez définir la profondeur de passe ap sans tenir compte de surépaisseurs sur les attaques de coulée.

PLAGE EFFECTIVE D'ÉVACUATION DES COPEAUX



TABLEAU DE RUGOSITÉ DE L'ÉTAT DE SURFACE DE FINITION (RZ) PAR RAPPORT À LA ROTATION

Corps de fraise	FMAX-125B24R
Plaquette (nuance)	GOER1408PXFR2 (MD2030)
Pièce	Culasse ADC12
n (tr/min ⁻¹)	8.000 – 12.000
Vc (m/min)	3.140 – 4.710
fz (mm/dent)	0.08
Vf (mm/min)	15.360 – 23.040
ap (mm)	2.0
ae (mm)	68 x 3 passes
Mode de coupe	Arrosage interne 4MPa
Machine	Centre d'usinage horizontal

Résultats

La fraise FMAX offre une très belle finition avec une usure prévisible et sans bavure.
Même avec une rotation élevée, avec la fraise FMAX, faible rugosité et un état de surface de haute qualité.

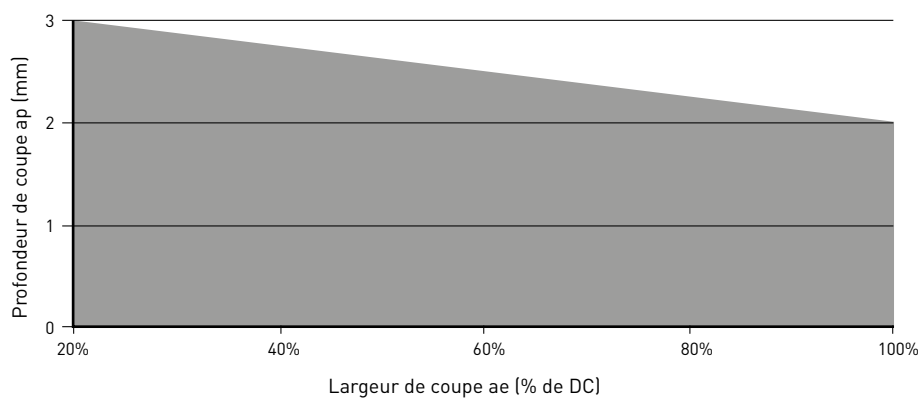
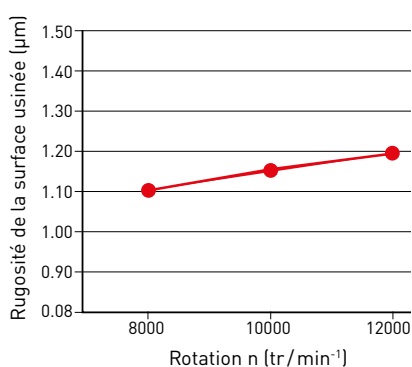

SÉRIE WWX

NOUVELLE FRAISE À SURFACER-DRESSER

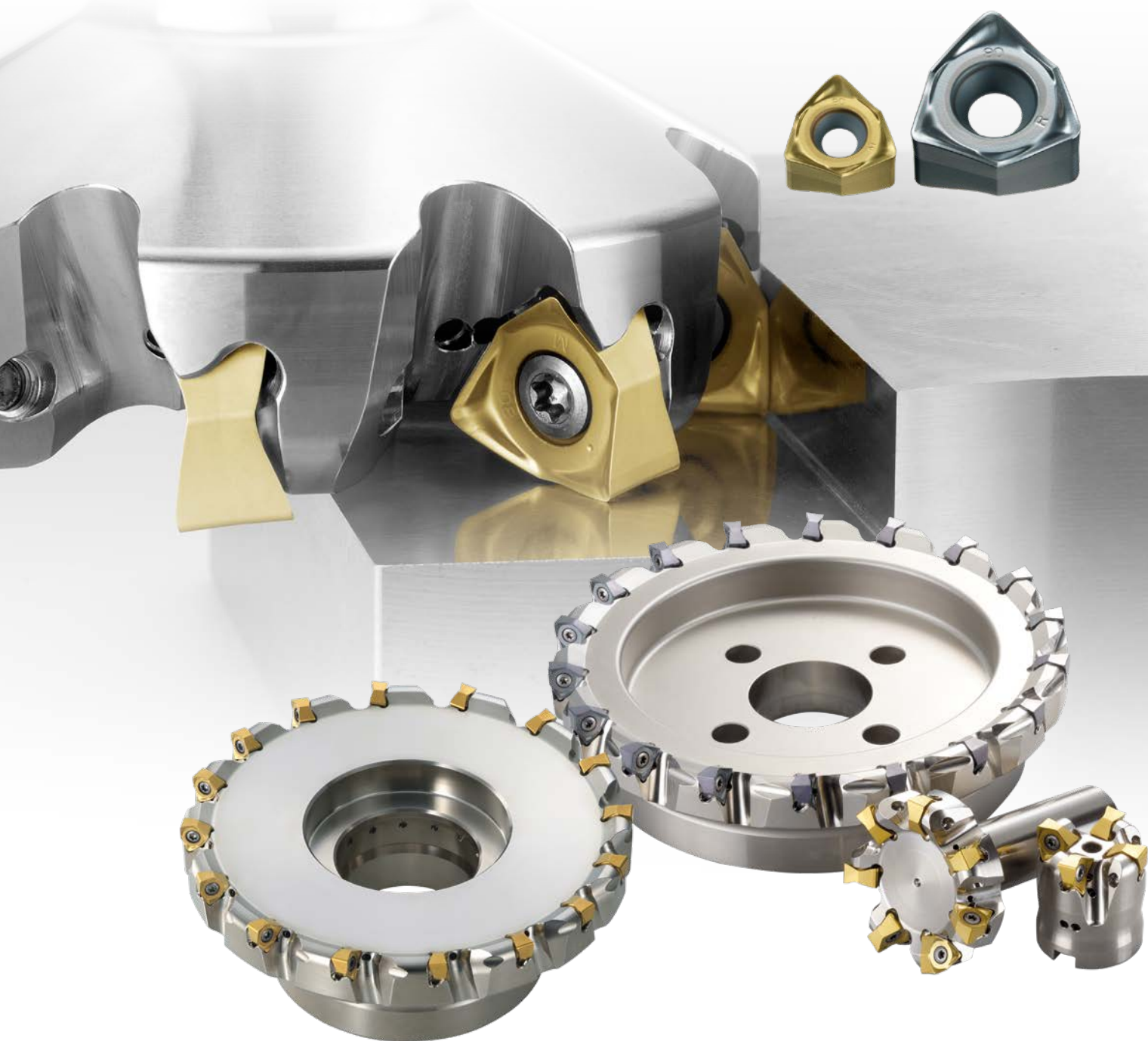

En savoir plus...

B260

www.mhg-mediastore.net

DIA EDGE

SÉRIE WWX

PERFORMANCE ET FIABILITÉ

Fraise à surfacer-dresser à hautes performances avec plaquettes trigones réversibles.

Les plaquettes réversibles à six arêtes de coupe réduisent le coût à l'arête et garantissent une excellente fiabilité d'usinage grâce à une plaquette négative spéciale assurant une coupe positive.

Le positionnement précis des plaquettes garantit une haute précision de dressage, permettant ainsi de supprimer des opérations de finition et donc de réduire les temps de cycles et les coûts de fabrication.

GAMME WWX200 :

- Attachement par alésage : DC 40 – 160 mm
- Queue cylindrique : DC 25 – 50 mm
- Rayons de plaquette : 0.4 – 0.8 mm
- Profondeur de passe : APMX 5 mm

GAMME WWX400 :

- Attachement par alésage : DC 50 – 250 mm
- Queue cylindrique : DC 50 – 80 mm
- Rayons de plaquette : 0.4 / 0.8 / 1.6 / 2.0 mm
- Profondeur de passe : APMX 8 mm

APPLICATIONS

- Usinage général
- Surfaçage
- Dressage/contournage



AVANTAGES

- Grande fiabilité
- Efforts de coupe réduits
- Bon contrôle du copeau
- Grande gamme de nuances et de brise-copeaux
- Plaquettes trigones réversibles à six arêtes de coupe
- Excellents états de surface

SÉRIE WWX

AVANTAGES

GAMME DE CORPS :

Les diamètres de 25 à 160 mm (WWX200) / 50 à 250 mm (WWX400) sont tous disponibles avec des géométries à pas large, standard et fin. Les nombreux diamètres disponibles permettent de choisir le corps de fraise optimal pour chaque application.

Tous les corps sont munis de l'arrosage au centre.

Pas extra fin | Pas normal

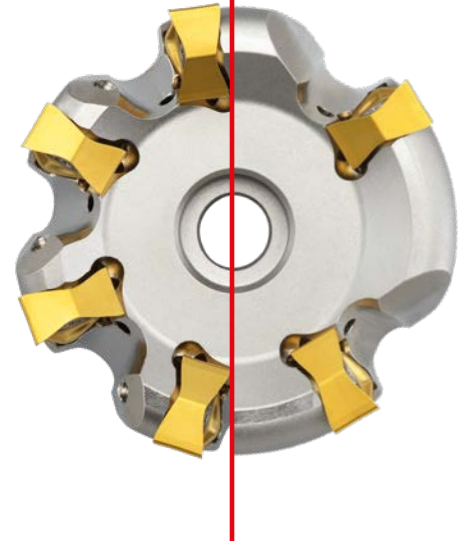

GRANDE PRÉCISION DE DRESSAGE AVEC UNE PROFONDEUR DE PASSE MAXIMALE DE 5 MM (WWX200) / 8 MM (WWX400)

Le positionnement particulier des plaquettes réduit les efforts de coupe et la prise de puissance. La grande précision des corps garantit la précision de dressage dans toutes conditions d'usinage.

PRISE DE PUISSANCE RÉDUITE

La géométrie de coupe positive de la plaquette réduit les efforts de coupe et la prise de puissance. La grande épaisseur de la plaquette assure une excellente résistance à l'écaillage.

ARÊTE DE PLANAGE À GRAND RAYON

Pour assurer un excellent état de surface, une arête de planage à grand rayon ($R = 100 \text{ mm}$) et d'une largeur BS de 0.5 – 1.7 mm est mise en œuvre sur la gamme entière de plaquettes (brise-copeaux L, M et R).

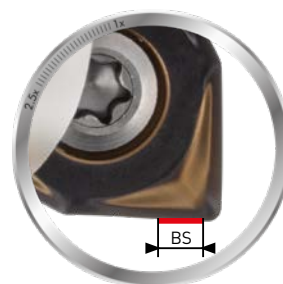

SÉRIE WWX

PLAQUETTES

POSITIONNEMENT PRÉCIS DES PLAQUETTES COMBINÉ À UN SERRAGE PUISSANT

Les quatre surfaces d'appui de la plaquette et l'utilisation d'une vis de serrage surdimensionnée permettent un serrage précis, robuste et fiable des plaquettes.

Le WWX200 / WWX400 peut donc être utilisée pour toutes les opérations de fraisage, de l'ébauche à la finition.



Géométrie renforcée en X

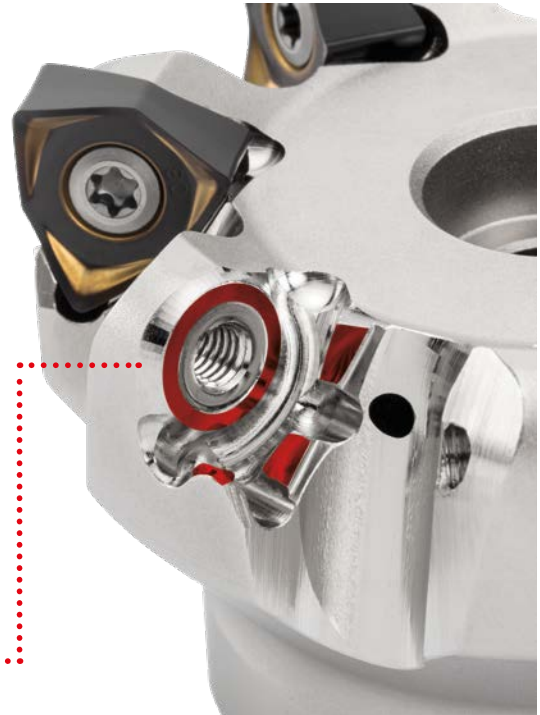

CONTRÔLE ET ÉVACUATION DES COPEAUX EN DRESSAGE DE PAROIS

L'arête de coupe convexe assure un bon enroulement des copeaux, facilitant ainsi leur évacuation pour éviter tout risque de recyclage.

WWX200 / WWX400



Conventionnel



SÉRIE WWX

NUANCES ET BRISE-COPEAUX

Grâce à une large gamme de nuances et de brise-copeaux, il est possible de faire le choix idéal pour un usinage stable et efficace dans une large gamme d'applications.

		<p>BRISE-COPEAUX L Recommandé pour la finition, pour réduire les efforts de coupe et pour l'usinage de l'aluminium et du titane.</p>
		<p>BRISE-COPEAUX M Excellent équilibre entre acuité et résistance d'arête. Première recommandation polyvalente pour une large gamme de matériaux et d'applications.</p>
		<p>BRISE-COPEAUX R Premier choix pour les conditions de coupe interrompues.</p>

NUANCES DE CARBURE POUR UNE LARGE GAMME DE MATIÈRES

P	M	K	N	S	H
P10	M10	K10	N10	S10	H10
P20	M20	K20	N20	S20	H20
P30	M30	K30	N30	S30	H30
P40	M40	K40	N40	S40	H40

MP6120

Pour l'usinage polyvalent de l'acier.

MP6130

Pour l'usinage interrompu de l'acier.

MP7130

Pour l'usinage polyvalent de l'acier inoxydable.

MC5020

Nuance CVD pour l'usinage à haute vitesse de la fonte.

MP9120

Pour l'usinage polyvalent des réfractaires et du titane.

MP9130

Pour l'usinage polyvalent des réfractaires et du titane.

TF15

Pour les alliages d'aluminium.

VP15TF

Nuance polyvalente résistant à l'usure. Particulièrement adaptée à l'usinage des fontes et des aciers traités.

UNE NOUVELLE PLATEFORME HAUTES PERFORMANCES

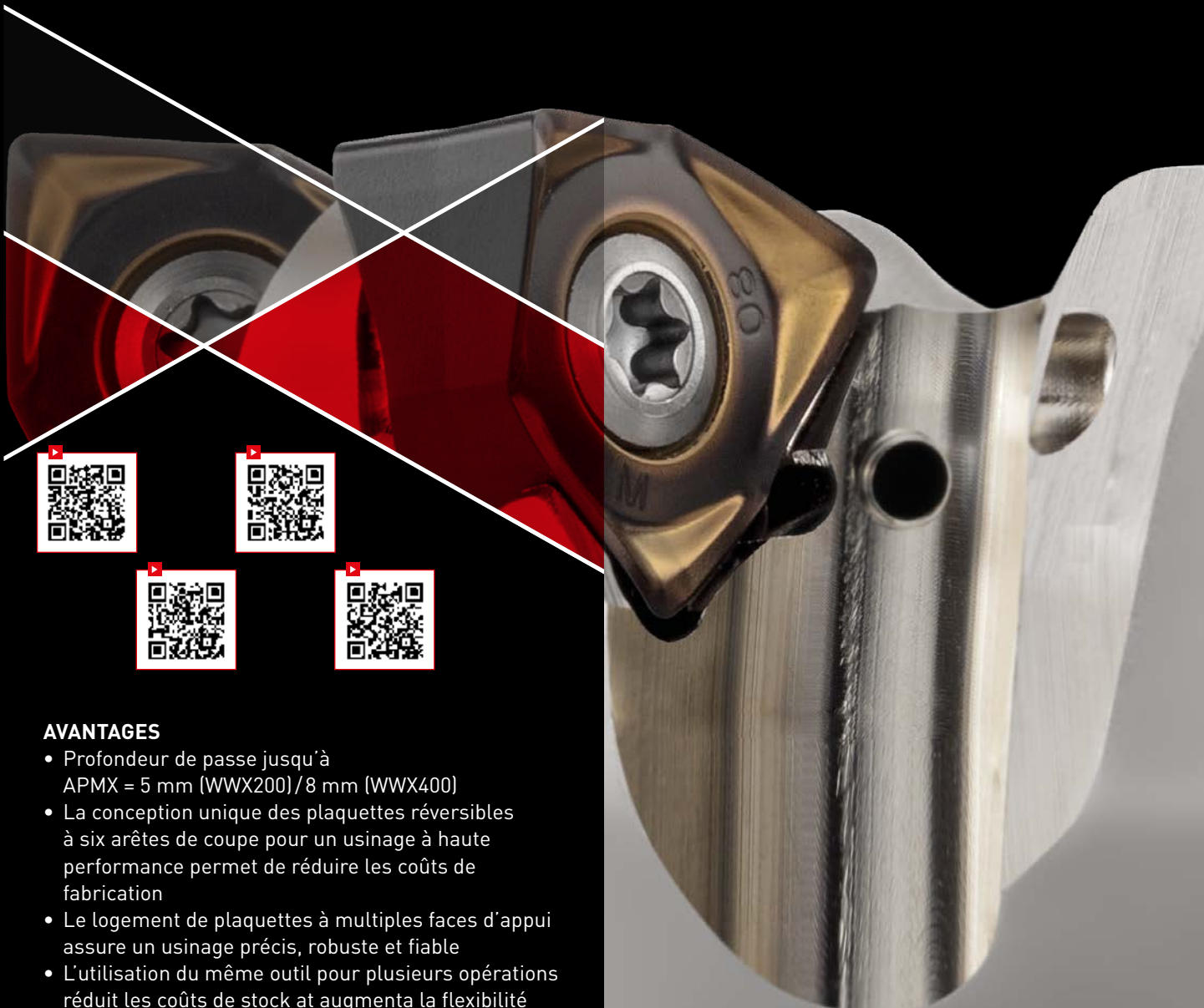

AVANTAGES

- Profondeur de passe jusqu'à APMX = 5 mm (WWX200)/8 mm (WWX400)
- La conception unique des plaquettes réversibles à six arêtes de coupe pour un usinage à haute performance permet de réduire les coûts de fabrication
- Le logement de plaquettes à multiples faces d'appui assure un usinage précis, robuste et fiable
- L'utilisation du même outil pour plusieurs opérations réduit les coûts de stock et augmente la flexibilité

WWX200



FRAISE À SURFACER-DRESSER

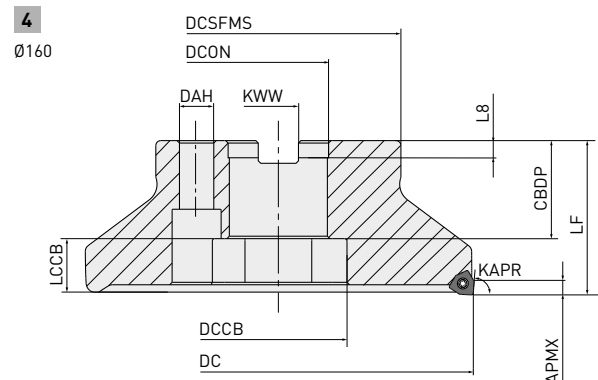
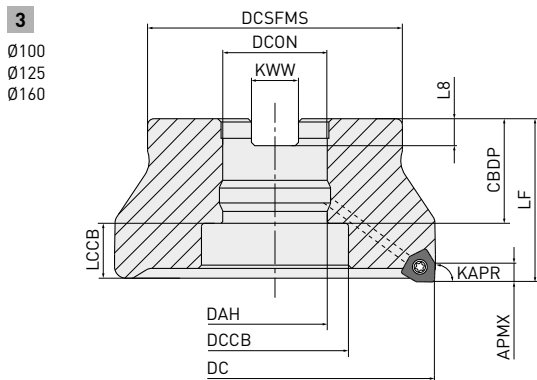
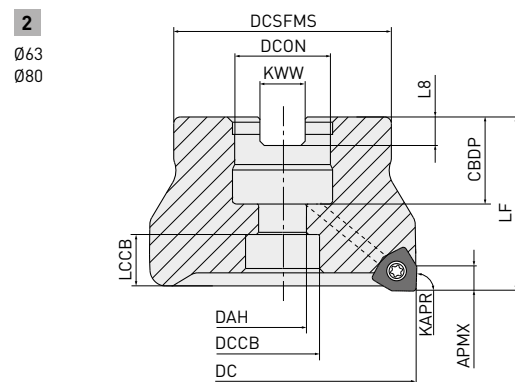
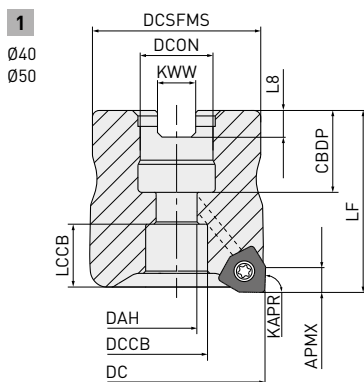

Outil à droite uniquement.

ATTACHEMENT PAR ALÉSAGE

Référence	Stock	APMX	DC	DCON	LF	RPMX	WT	ZEFP		Type
WWX200-040A03AR	●	5	40	16	40	21600	0.2	3	○	1
WWX200-040A04AR	●	5	40	16	40	21600	0.2	4	○	1
WWX200-050A04AR	●	5	50	22	40	18600	0.4	4	○	1
WWX200-050A05AR	●	5	50	22	40	18600	0.4	5	○	1
WWX200-050A06AR	●	5	50	22	40	18600	0.3	6	○	1
WWX200-063A05AR	●	5	63	22	40	16000	0.5	5	○	2
WWX200-063A06AR	●	5	63	22	40	16000	0.5	6	○	2
WWX200-063A07AR	●	5	63	22	40	16000	0.5	7	○	2
WWX200-080A05AR	●	5	80	27	50	13600	1.1	5	○	2
WWX200-080A07AR	●	5	80	27	50	13600	1.0	7	○	2

WWX200 – FRAISE À SURFACER-DRESSER – ATTACHEMENT PAR ALÉSAGE

Référence	Stock	APMX	DC	DCON	LF	RPMX	WT	ZEFP		Type
WWX200-080A09AR	●	5	80	27	50	13600	1.0	9	○	2
WWX200-100B06AR	●	5	100	32	50	11700	1.7	6	○	3
WWX200-100B08AR	●	5	100	32	50	11700	1.7	8	○	3
WWX200-100B11AR	●	5	100	32	50	11700	1.7	11	○	3
WWX200-125B07AR	●	5	125	40	63	10100	3.1	7	○	3
WWX200-125B11AR	●	5	125	40	63	10100	3.0	11	○	3
WWX200-125B14AR	●	5	125	40	63	10100	3.0	14	○	3
WWX200-160C09NR	●	5	160	40	63	8600	4.6	9	—	4
WWX200-160C12NR	●	5	160	40	63	8600	4.6	12	—	4
WWX200-160C16NR	●	5	160	40	63	8600	4.6	16	—	4

1. Pour des raisons de sécurité, veuillez respecter les vitesses de rotation maximales autorisées RPMX.
2. Lors d'une utilisation à haute vitesse de rotation, veuillez au bon équilibrage de l'ensemble fraise + attachement.
3. ○ = Avec trous d'arrosage
4. Les corps de fraise sont livrés sans vis d'attachement. Veuillez vous référer à la p. 111 pour la référence.
5. Veuillez utiliser une vis d'attachement de type FMC pour les corps de diamètre 40 à 100.
6. Veuillez utiliser une vis d'attachement de type FMA pour les corps de diamètre 125 à 160.

113 

DIMENSIONS DE MONTAGE

Référence	CBDP	DAH	DCCB	DCON	DCSFMS	KWW	LCCB	L8	Type
WWX200-040A03AR	18	9	13.6	16	37	8.4	13.8	5.6	1
WWX200-040A04AR	18	9	13.6	16	37	8.4	13.8	5.6	1
WWX200-050A04AR	20	11	17	22	47	10.4	11.8	6.3	1
WWX200-050A05AR	20	11	17	22	47	10.4	11.8	6.3	1
WWX200-050A06AR	20	11	17	22	47	10.4	11.8	6.3	1
WWX200-063A05AR	20	11	17	22	50	10.4	11.8	6.3	2
WWX200-063A06AR	20	11	17	22	50	10.4	11.8	6.3	2
WWX200-063A07AR	20	11	17	22	50	10.4	11.8	6.3	2
WWX200-080A05AR	23	13	20	27	56	12.4	11.8	7	2
WWX200-080A07AR	23	13	20	27	56	12.4	11.8	7	2
WWX200-080A09AR	23	13	20	27	56	12.4	11.8	7	2
WWX200-100B06AR	26	32	45	32	78	14.4	16.8	8	3
WWX200-100B08AR	26	32	45	32	78	14.4	16.8	8	3
WWX200-100B11AR	26	32	45	32	78	14.4	16.8	8	3
WWX200-125B07AR	35	42	56	40	89	16.4	21.8	9	3
WWX200-125B11AR	35	42	56	40	89	16.4	21.8	9	3
WWX200-125B14AR	35	42	56	40	89	16.4	21.8	9	3
WWX200-160C09NR	40	—	56	40	100	16.4	21.8	9	4
WWX200-160C12NR	40	—	56	40	100	16.4	21.8	9	4
WWX200-160C16NR	40	—	56	40	100	16.4	21.8	9	4

WWX200



FRAISE À SURFACER-DRESSER

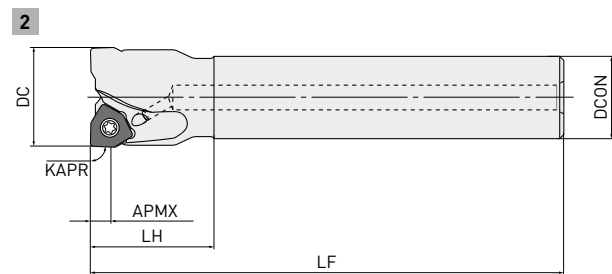
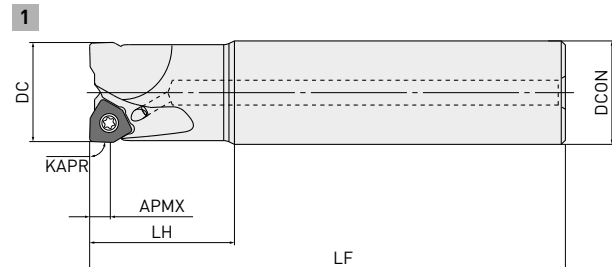

Outil à droite uniquement.

QUEUE CYLINDRIQUE

Référence	Stock	APMX	DC	DCON	LF	RPMX	WT	LH	ZEFP		Type
WWX200R2502SA20S	●	5	25	20	115	29600	0.3	30	2	○	2
WWX200R2502SA25S	●	5	25	25	115	29600	0.4	35	2	○	1
WWX200R2502SA25L	●	5	25	25	170	29600	0.6	70	2	○	1
WWX200R2802SA25S	●	5	28	25	115	27400	0.4	35	2	○	2
WWX200R2802SA25L	●	5	28	25	170	27400	0.6	35	2	○	2
WWX200R3002SA25S	●	5	30	25	125	26200	0.5	35	2	○	2
WWX200R3202SA32S	●	5	32	32	125	26200	0.7	45	2	○	1
WWX200R3203SA32S	●	5	32	32	125	26200	0.7	45	3	○	1
WWX200R3203SA32L	●	5	32	32	190	26200	1.0	90	3	○	1
WWX200R3503SA32L	●	5	35	32	190	25100	1.1	45	3	○	2
WWX200R4003SA32S	★	5	40	32	125	21600	0.8	45	3	○	2
WWX200R4004SA32S	★	5	40	32	125	21600	0.8	45	4	○	2
WWX200R5004SA32S	★	5	50	32	125	18600	0.9	45	4	○	2
WWX200R5005SA32S	★	5	50	32	125	18600	0.9	45	5	○	2
WWX200R5006SA32S	★	5	50	32	125	18600	0.9	45	6	○	2

1. Pour des raisons de sécurité, veuillez respecter les vitesses de rotation maximales autorisées RPMX.
2. Lors d'une utilisation à haute vitesse de rotation, veuillez au bon équilibrage de l'ensemble fraise + attachement.
3. ○ = Avec trous d'arrosage



WWX200

PIÈCES DÉTACHÉES – VIS D'ATTACHEMENT

Corps de fraise	Vis d'attacheement		Type	Dimensions							Géométrie
	Avec trous d'arrosage	Sans trous d'arrosage		a	b	c	d	e	f	g	
	Référence	Référence									
WWX200-040A [○] AR	HSC08025H	—	1	13	M8x1.25	33	8	5	—	—	
WWX200-050A [○] AR	HSC10030H	HSC10035	1	16	M10x1.5	40 (45)	10	6	—	—	
WWX200-063A [○] AR	HSC10030H	HSC10035	1	16	M10x1.5	40 (45)	10	6	—	—	
WWX200-080A [○] AR	HSC12035H	HSC12035	1	18	M12x1.75	47	12	10	—	—	
WWX200-100B [○] AR	MBA16033H	—	2	40	M16x2	43	10	14	6	23	
WWX200-125B [○] AR	MBA20040H	—	2	50	M20x2.5	54	14	17	6	27	
WWX200-160C [○] NR	—	—	2	50	M20x2.5	54	14	17	6	27	

1. Vis d'attacheement pour arrosage interne.

PIÈCES DÉTACHÉES

Type de porte-outil	 *		
	Vis de plaquette	Clef (plaquette)	Lubrifiant antigrippant
Attacheement par alésage	TPS3R	TIP10D	MK1KS
Queue cylindrique			

* Couple de serrage : TPS3R = 2.0 Nm

WWX200

PLAQUETTES

Référence	Classe	Honing	MP6120	MP6130	MP7130	MP9120	MP9130	VP15TF	TF15	MC5020	IC	S	S1	BS	RE	Géométrie	
																Plaque à droite uniquement.	
P	Acier		●	●				✱									
M	Acier inoxydable				●			●									
K	Fonte ductile							✱		●							
N	Alliage d'aluminium								●								
S	Alliages réfractaires, titane					●	●										
H	Aciers trempés/traités		●					●									

NEW	6NGU0906040PNFR-L	G	F						●		9.0	4.5	5.3	1.3	0.4	
NEW	6NGU0906080PNFR-L	G	F						●		9.0	4.5	5.3	1.3	0.8	
	6NNU0906040PNER-M	M	E	●	●	●	●	●	●		9.0	5.3	6.1	1.6	0.4	
	6NNU0906080PNER-M	M	E	●	●	●	●	●	●		9.0	5.3	6.1	1.2	0.8	
	6NNU0906080PNER-R	M	E	●	●		●	●	●		9.0	5.3	6.1	1.2	0.8	

(Conditionnement par 10)

WWX400

PLAQUETTES

Référence	Classe	Honing	MP6120	MP6130	MP7130	MP9120	MP9130	VP15TF	TF15	MC5020	IC	S	S1	BS	RE	Géométrie	
																Plaque à droite uniquement.	
P	Acier		●	●				✱									
M	Acier inoxydable				●			●									
K	Fonte ductile							✱		●							
N	Alliage d'aluminium								●								
S	Alliages réfractaires, titane					●	●										
H	Aciers trempés/traités		●					●									

6NGU1409040PNER-L	G	E	●	●	●	●	●	●		●	14	7	9	1.7	0.4	
6NGU1409080PNER-L	G	E	●	●	●	●	●		●	14	7	9	1.3	0.8		
6NGU1409040PNFR-L	G	F							●	14	7	9	1.7	0.4		
6NGU1409080PNFR-L	G	F							●	14	7	9	1.3	0.8		
6NNU1409040PNER-M	M	E	●	●	●	●	●	●	●	14	7	9	1.7	0.4		
6NNU1409080PNER-M	M	E	●	●	●	●	●	●	●	14	7	9	1.3	0.8		
6NNU1409040PNER-M	M	E	●	●	●	●	●	●	●	14	7	9	1.7	0.4		
6NNU1409080PNER-M	M	E	●	●	●	●	●	●	●	14	7	9	1.3	0.8		
6NNU1409160PNER-M	M	E	●	●	●	●	●	●	●	14	7	9	0.5	1.6		
6NNU1409200PNER-M	M	E	●	●	●	●	●	●	●	14	7	9	0.5	2.0		
6NNU1409080PNER-R	M	E	●	●	●	●	●	●	●	14	7	9	1.3	0.8		
6NNU1409160PNER-R	M	E	●	●	●	●	●	●	●	14	7	9	0.5	1.6		
6NNU1409200PNER-R	M	E	●	●	●	●	●	●	●	14	7	9	0.5	2.0		
2NGU1406ZNER6C-M	G	E	●						●	●	14	6.3	—	6.5	—	

(Conditionnement par 10)

WWX200 / 400

CONDITIONS DE COUPE RECOMMANDÉES

VITESSE DE COUPE/USINAGE À SEC

Matière	Propriétés	Conditions de stabilité	Nuance	Vc			
				ae ≤ 0.5 DC	ae ≤ 0.8 DC	ae = DC	
Acier doux	≤180HB	●	MP6120	240 (200–280)	220 (180–260)	200 (160–240)	
		●	MP6130	230 (190–270)	210 (170–250)	190 (150–230)	
		✘	MP6130	210 (170–250)	190 (150–230)	170 (130–210)	
		✘	VP15TF	210 (170–250)	190 (150–230)	170 (130–210)	
Acier carbone Acier allié Acier outil allié	180 – 280HB	●	MP6120	210 (170–250)	190 (150–230)	170 (130–210)	
		●	MP6130	200 (160–240)	180 (140–220)	160 (120–200)	
		✘	MP6130	180 (140–220)	160 (120–200)	140 (100–180)	
		✘	VP15TF	180 (140–220)	160 (120–200)	140 (100–180)	
Acier carbone Acier allié Acier outil allié	280 – 350HB ≤350HB	●	MP6120	200 (160–240)	180 (140–220)	160 (120–200)	
		●	MP6130	190 (150–230)	170 (130–210)	150 (110–190)	
		✘	MP6130	170 (130–210)	150 (110–190)	130 (90–170)	
		✘	VP15TF	170 (130–210)	150 (110–190)	130 (90–170)	
Acier pré-traité	35 – 45HRC	●	MP6120	140 (120–160)	–	–	
		●	MP6130	120 (100–140)	–	–	
		✘	MP6130	110 (90–130)	–	–	
		✘	VP15TF	110 (90–130)	–	–	
Acier inoxydable austénitique	≤200HB	●	MP7130	180 (160–200)	160 (140–180)	–	
		●	MP7130	170 (150–190)	150 (130–170)	–	
		●	VP15TF	170 (150–190)	150 (130–170)	–	
		✘	MP7130	150 (130–170)	130 (110–150)	–	
	>200HB	✘	VP15TF	150 (130–170)	130 (110–150)	–	
		●	MP7130	170 (150–190)	150 (130–170)	–	
		●	MP7130	160 (140–180)	140 (120–160)	–	
		●	VP15TF	160 (140–180)	140 (120–160)	–	
Acier inoxydable ferritique ou martensitique	≤200HB	✘	MP7130	140 (120–160)	120 (100–140)	–	
		✘	VP15TF	140 (120–160)	120 (100–140)	–	
		●	MP7130	180 (160–200)	160 (140–180)	–	
		●	MP7130	170 (150–190)	150 (130–170)	–	
Acier inoxydable duplex	≤280HB	●	VP15TF	170 (150–190)	150 (130–170)	–	
		✘	MP7130	150 (130–170)	130 (110–150)	–	
		✘	VP15TF	150 (130–170)	130 (110–150)	–	
		✘	MP7130	130 (110–150)	110 (90–130)	–	
Inox à durcissement structural (PH)	<450HB	●	VP15TF	130 (110–150)	110 (90–130)	–	
		●	MP7130	140 (120–160)	–	–	
		●	MP7130	130 (110–150)	–	–	
		●	VP15TF	130 (110–150)	–	–	
			✘	MP7130	110 (90–130)	–	–
			✘	VP15TF	110 (90–130)	–	–

WWX200 / 400

VITESSE DE COUPE / USINAGE À SEC

Matière	Propriétés	Conditions de stabilité	Nuance	Vc		
				ae ≤ 0.5 DC	ae ≤ 0.8 DC	ae = DC
Fonte grise	≤350MPa	●	MC5020	250 (210-290)	230 (190-270)	210 (170-250)
		●	MC5020	240 (200-280)	220 (180-260)	200 (160-240)
		●	VP15TF	240 (200-280)	220 (180-260)	—
		✘	MC5020	220 (180-260)	200 (160-240)	180 (140-220)
		✘	VP15TF	220 (180-260)	200 (160-240)	180 (140-220)
K Fonte ductile	≤450MPa	●	MC5020	220 (180-260)	200 (160-240)	180 (140-220)
		●	MC5020	210 (170-250)	190 (150-230)	170 (130-210)
		●	VP15TF	210 (170-250)	190 (150-230)	—
		✘	MC5020	190 (150-230)	170 (130-210)	150 (110-190)
		✘	VP15TF	190 (150-230)	170 (130-210)	150 (110-190)
Fonte ductile	≤800MPa	●	MC5020	180 (140-220)	160 (120-200)	140 (100-180)
		●	MC5020	170 (130-210)	150 (110-190)	130 (90-170)
		●	VP15TF	170 (130-210)	150 (110-190)	—
		✘	MC5020	150 (110-190)	130 (90-170)	110 (70-150)
		✘	VP15TF	150 (110-190)	130 (90-170)	110 (70-150)
H Acier traité	40 - 55HRC	●●	VP15TF	50 (30- 70)	—	—
		●	MP6120	40 (30- 70)	—	—

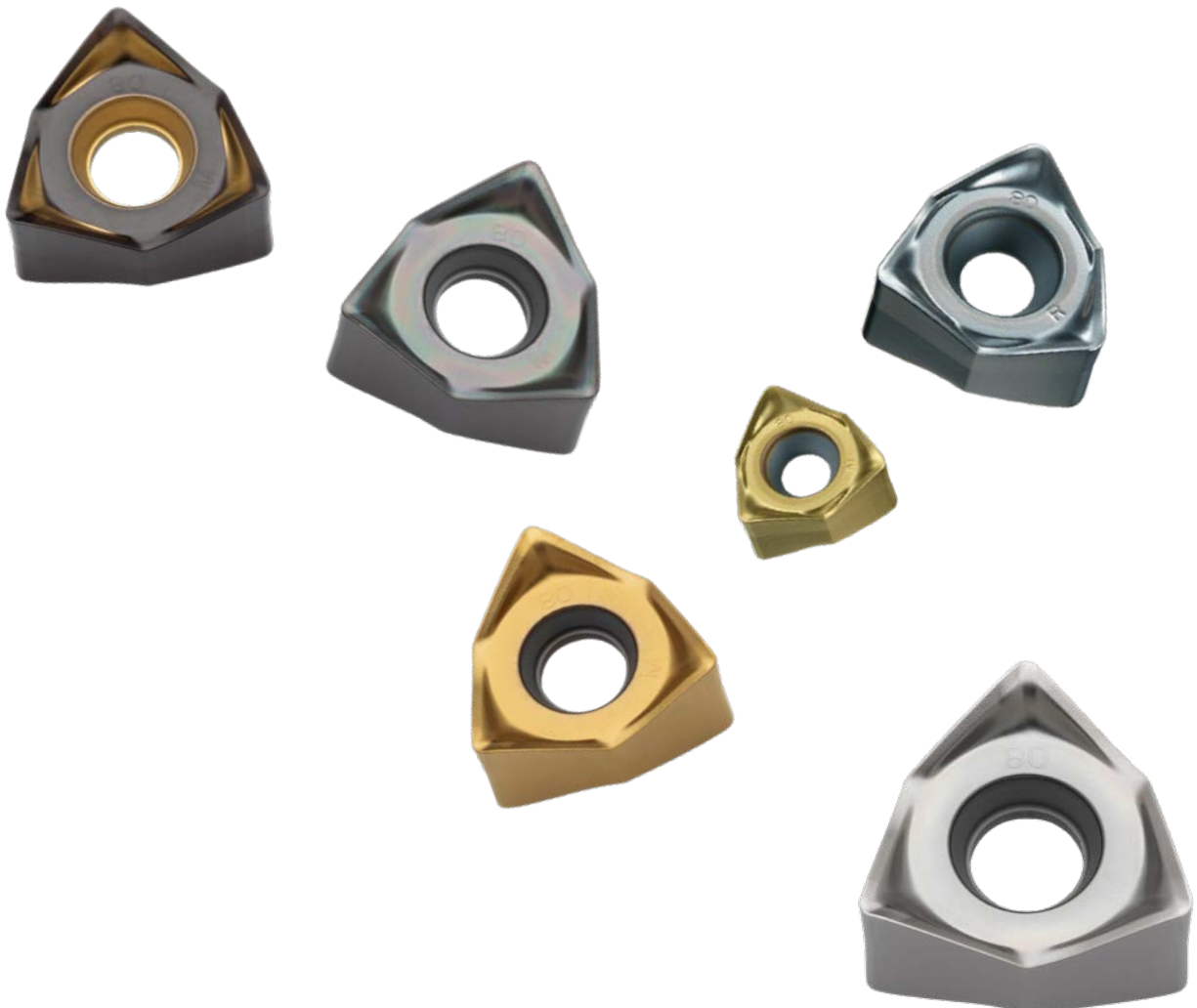

WWX200 / 400

CONDITIONS DE COUPE RECOMMANDÉES

VITESSE DE COUPE/COUPE LUBRIFIÉE

Matière	Propriétés	Conditions de stabilité	Nuance	Vc		
				ae ≤ 0.5 DC	ae ≤ 0.8 DC	ae = DC
Acier doux	≤180HB	●	MP6120	150 (140-160)	130 (120-140)	120 (110-130)
		●	MP6130	140 (130-150)	120 (110-130)	110 (100-120)
		✚	MP6130	120 (110-130)	100 (90-110)	90 (80-100)
		✚	VP15TF	120 (110-130)	100 (90-110)	90 (80-100)
Acier carbone Acier allié Acier outil allié	180 - 280HB	●	MP6120	150 (140-160)	130 (120-140)	120 (110-130)
		●	MP6130	140 (130-150)	120 (110-130)	110 (100-120)
		✚	MP6130	120 (110-130)	100 (90-110)	90 (80-100)
Acier carbone Acier allié Acier outil allié	280 - 350HB ≤350HB	●	MP6120	140 (130-150)	120 (110-130)	110 (100-120)
		●	MP6130	130 (120-140)	110 (100-120)	100 (90-110)
		✚	MP6130	110 (100-120)	90 (80-100)	80 (70- 90)
		✚	VP15TF	110 (100-120)	90 (80-100)	80 (70- 90)
Acier pré-traité	35 - 45HRC	●	MP6120	110 (100-120)	—	—
		●	MP6130	100 (90-110)	—	—
		✚	MP6130	80 (70- 90)	—	—
		✚	VP15TF	80 (70- 90)	—	—
Acier inoxydable austénitique	≤200HB	●	MP7130	130 (120-140)	110 (100-120)	—
		●	MP7130	120 (110-130)	100 (90-110)	—
		●	VP15TF	120 (110-130)	100 (90-110)	—
		✚	MP7130	100 (90-110)	80 (70- 90)	—
	>200HB	✚	VP15TF	100 (90-110)	80 (70- 90)	—
		●	MP7130	130 (120-140)	110 (100-120)	—
		●	MP7130	120 (110-130)	100 (90-110)	—
		●	VP15TF	120 (110-130)	100 (90-110)	—
Acier inoxydable ferritique ou martensitique	≤200HB	✚	MP7130	100 (90-110)	80 (70- 90)	—
		✚	VP15TF	100 (90-110)	80 (70- 90)	—
		●	MP7130	130 (120-140)	110 (100-120)	—
		●	MP7130	120 (110-130)	100 (90-110)	—
		●	VP15TF	120 (110-130)	100 (90-110)	—
		✚	MP7130	100 (90-110)	80 (70- 90)	—
Acier inoxydable duplex	≤280HB	✚	VP15TF	100 (90-110)	80 (70- 90)	—
		●	MP7130	120 (110-130)	100 (90-110)	—
		●	MP7130	110 (100-120)	90 (80-100)	—
		●	VP15TF	110 (100-120)	90 (80-100)	—
		✚	MP7130	90 (80-100)	70 (60- 80)	—
Inox à durcissement structural (PH)	<450HB	✚	VP15TF	90 (80-100)	70 (60- 80)	—
		●	MP7130	120 (110-130)	—	—
		●	MP7130	110 (100-120)	—	—
		●	VP15TF	110 (100-120)	—	—
		✚	MP7130	90 (80-100)	—	—
		✚	VP15TF	90 (80-100)	—	—

WWX200 / 400

VITESSE DE COUPE / COUPE LUBRIFIÉE

Matière	Propriétés	Conditions de stabilité	Nuance	Vc		
				ae ≤ 0.5 DC	ae ≤ 0.8 DC	ae = DC
K	Fonte grise	≤350MPa	● MC5020	170 (150-190)	150 (130-170)	130 (110-150)
			● MC5020	160 (140-180)	140 (120-160)	120 (100-140)
			● VP15TF	160 (140-180)	140 (120-160)	—
			✘ MC5020	140 (120-160)	120 (100-140)	100 (80-120)
			✘ VP15TF	140 (120-160)	120 (100-140)	100 (80-120)
K	Fonte ductile	≤450MPa	● MC5020	170 (150-190)	150 (130-170)	130 (110-150)
			● MC5020	160 (140-180)	140 (120-160)	120 (100-140)
			● VP15TF	160 (140-180)	140 (120-160)	—
			✘ MC5020	140 (120-160)	120 (100-140)	100 (80-120)
			✘ VP15TF	140 (120-160)	120 (100-140)	100 (80-120)
K	Fonte ductile	≤800MPa	● MC5020	160 (150-170)	140(130-150)	120 (110-130)
			● MC5020	150 (140-160)	130 (120-140)	110 (100-120)
			● VP15TF	150 (140-160)	130 (120-140)	—
			✘ MC5020	130 (120-140)	110 (100-120)	90 (80-100)
			✘ VP15TF	130 (120-140)	110 (100-120)	90 (80-100)
N	Alliage d'aluminium	Si<5%	● TF15	500 (300-900)	500 (300-900)	500 (300-900)
			● TF15	500 (300-900)	500 (300-900)	500 (300-900)
			✘ TF15	400 (200-800)	400 (200-800)	400 (200-800)
S	Alliage de titane	—	● MP9120	80 (60-100)	—	—
			● MP9120	70 (50- 90)	—	—
			✘ MP9130	60 (40- 80)	—	—
	Alliage réfractaire	—	● MP9120	60 (50- 70)	—	—
			● MP9120	50 (30- 60)	—	—
H	Acier traité	40 - 55HRC	● VP15TF	50 (30- 70)	—	—
			● MP6120	40 (30- 70)	—	—
			● MP6120	40 (30- 70)	—	—

1. Pour une bonne évacuation des copeaux, nous conseillons le soufflage d'air ou l'arrosage au centre.
2. En cas de vibrations, veuillez réduire les conditions de coupe.
3. En coupe interrompue, veuillez réduire la rotation et l'avance de 20 %.

WWX200







CONDITIONS DE COUPE RECOMMANDÉES

PROFONDEUR DE PASSE / AVANCE PAR DENT

Matière	Propriétés	Conditions de stabilité	Arrosage	Nuance	ae ≤ 0.5 DC		ae ≤ 0.8 DC		ae = DC	
					ap	fz	ap	fz	ap	fz
Acier doux	≤180HB	●	✗	MP6120	M	≤ 3.0 0.13 [0.10-0.15]	M	≤ 3.0 0.13 [0.10-0.15]	M	≤ 2.0 0.13 [0.10-0.15]
		●	✗	MP6130	M	≤ 3.0 0.13 [0.10-0.15]	M	≤ 3.0 0.13 [0.10-0.15]	M	≤ 2.0 0.13 [0.10-0.15]
		●	✗	MP6130	R	≤ 3.0 0.16 [0.10-0.20]	R	≤ 3.0 0.16 [0.10-0.20]	—	—
		✚	✗	MP6130	R	≤ 3.0 0.13 [0.10-0.15]	R	≤ 3.0 0.13 [0.10-0.15]	M	≤ 2.0 0.13 [0.10-0.15]
		✚	✗	VP15TF	R	≤ 3.0 0.13 [0.10-0.15]	R	≤ 3.0 0.13 [0.10-0.15]	M	≤ 2.0 0.13 [0.10-0.15]
Acier carbone Acier allié Acier outil allié	180 – 280HB	●	✗	MP6120	M	≤ 3.0 0.13 [0.10-0.15]	M	≤ 3.0 0.13 [0.10-0.15]	M	≤ 2.0 0.13 [0.10-0.15]
		●	✗	MP6130	M	≤ 3.0 0.13 [0.10-0.15]	M	≤ 3.0 0.13 [0.10-0.15]	M	≤ 2.0 0.13 [0.10-0.15]
		●	✗	MP6130	R	≤ 3.0 0.16 [0.10-0.20]	R	≤ 3.0 0.16 [0.10-0.20]	—	—
		✚	✗	MP6130	R	≤ 3.0 0.13 [0.10-0.15]	R	≤ 3.0 0.13 [0.10-0.15]	M	≤ 2.0 0.13 [0.10-0.15]
		✚	✗	VP15TF	R	≤ 3.0 0.13 [0.10-0.15]	R	≤ 3.0 0.13 [0.10-0.15]	M	≤ 2.0 0.13 [0.10-0.15]
Acier carbone Acier allié Acier outil allié	280 – 350HB ≤350HB	●	✗	MP6120	M	≤ 3.0 0.13 [0.10-0.15]	M	≤ 3.0 0.13 [0.10-0.15]	M	≤ 2.0 0.13 [0.10-0.15]
		●	✗	MP6130	M	≤ 3.0 0.13 [0.10-0.15]	M	≤ 3.0 0.13 [0.10-0.15]	M	≤ 2.0 0.13 [0.10-0.15]
		●	✗	MP6130	R	≤ 3.0 0.16 [0.10-0.20]	R	≤ 3.0 0.16 [0.10-0.20]	—	—
		✚	✗	MP6130	R	≤ 3.0 0.13 [0.10-0.15]	R	≤ 3.0 0.13 [0.10-0.15]	M	≤ 2.0 0.13 [0.10-0.15]
		✚	✗	VP15TF	R	≤ 3.0 0.13 [0.10-0.15]	R	≤ 3.0 0.13 [0.10-0.15]	M	≤ 2.0 0.13 [0.10-0.15]
Acier pré-traité	35 – 45HRC	●	✗	MP6120	M	≤ 2.0 0.13 [0.10-0.15]	—	—	—	—
		●	✗	MP6130	M	≤ 2.0 0.13 [0.10-0.15]	—	—	—	—
		●	✗	MP6130	R	≤ 2.0 0.16 [0.10-0.20]	—	—	—	—
		✚	✗	MP6130	R	≤ 2.0 0.13 [0.10-0.15]	—	—	—	—
		✚	✗	VP15TF	R	≤ 2.0 0.13 [0.10-0.15]	—	—	—	—

WWX200

PROFONDEUR DE PASSE / AVANCE PAR DENT

Matière	Propriétés	Conditions de stabilité Arrosage	Nuance	ae ≤ 0.5 DC			ae ≤ 0.8 DC			ae = DC		
												
M	Acier inoxydable austénitique	≤200HB	●●● X MP7130 M ≤ 3.0 0.13 [0.10-0.15]	M ≤ 3.0 0.13 [0.10-0.15]	M ≤ 3.0 0.13 [0.10-0.15]	—	—	—	—	—	—	
			●●● X VP15TF M ≤ 3.0 0.16 [0.10-0.20]	M ≤ 3.0 0.16 [0.10-0.20]	M ≤ 3.0 0.16 [0.10-0.20]	—	—	—				
			●●● X MP7130 M ≤ 3.0 0.13 [0.10-0.15]	M ≤ 3.0 0.13 [0.10-0.15]	M ≤ 3.0 0.13 [0.10-0.15]	—	—	—				
			●●● X VP15TF M ≤ 3.0 0.13 [0.10-0.15]	M ≤ 3.0 0.13 [0.10-0.15]	M ≤ 3.0 0.13 [0.10-0.15]	—	—	—				
		>200HB	●●● X MP7130 M ≤ 2.0 0.13 [0.10-0.15]	M ≤ 3.0 0.13 [0.10-0.15]	M ≤ 3.0 0.13 [0.10-0.15]	—	—	—				
			●●● X MP7130 M ≤ 3.0 0.13 [0.10-0.15]	M ≤ 3.0 0.13 [0.10-0.15]	M ≤ 3.0 0.13 [0.10-0.15]	—	—	—				
			●●● X VP15TF M ≤ 2.0 0.16 [0.10-0.20]	M ≤ 3.0 0.16 [0.10-0.20]	M ≤ 3.0 0.16 [0.10-0.20]	—	—	—				
			●●● X VP15TF M ≤ 3.0 0.16 [0.10-0.20]	M ≤ 3.0 0.16 [0.10-0.20]	M ≤ 3.0 0.16 [0.10-0.20]	—	—	—				
	Acier inoxydable ferritique ou martensitique	≤200HB	●●● X MP7130 M ≤ 3.0 0.13 [0.10-0.15]	M ≤ 3.0 0.13 [0.10-0.15]	M ≤ 3.0 0.13 [0.10-0.15]	—	—	—				
			●●● X VP15TF M ≤ 3.0 0.16 [0.10-0.20]	M ≤ 3.0 0.16 [0.10-0.20]	M ≤ 3.0 0.16 [0.10-0.20]	—	—	—				
			●●● X MP7130 M ≤ 3.0 0.13 [0.10-0.15]	M ≤ 3.0 0.13 [0.10-0.15]	M ≤ 3.0 0.13 [0.10-0.15]	—	—	—				
			●●● X VP15TF M ≤ 3.0 0.13 [0.10-0.15]	M ≤ 3.0 0.13 [0.10-0.15]	M ≤ 3.0 0.13 [0.10-0.15]	—	—	—				
	Acier inoxydable duplex	≤280HB	●●● X MP7130 M ≤ 2.0 0.13 [0.10-0.15]	M ≤ 3.0 0.13 [0.10-0.15]	M ≤ 3.0 0.13 [0.10-0.15]	—	—	—				
			●●● X MP7130 M ≤ 3.0 0.13 [0.10-0.15]	M ≤ 3.0 0.13 [0.10-0.15]	M ≤ 3.0 0.13 [0.10-0.15]	—	—	—				
			●●● X VP15TF M ≤ 2.0 0.16 [0.10-0.20]	M ≤ 3.0 0.16 [0.10-0.20]	M ≤ 3.0 0.16 [0.10-0.20]	—	—	—				
			●●● X VP15TF M ≤ 3.0 0.16 [0.10-0.20]	M ≤ 3.0 0.16 [0.10-0.20]	M ≤ 3.0 0.16 [0.10-0.20]	—	—	—				
●●● X MP7130 M ≤ 2.0 0.13 [0.10-0.15]			M ≤ 3.0 0.16 [0.10-0.20]	M ≤ 3.0 0.16 [0.10-0.20]	—	—	—					
●●● X MP7130 M ≤ 3.0 0.13 [0.10-0.15]			M ≤ 3.0 0.13 [0.10-0.15]	M ≤ 3.0 0.13 [0.10-0.15]	—	—	—					
●●● X VP15TF M ≤ 2.0 0.13 [0.10-0.15]			M ≤ 3.0 0.16 [0.10-0.20]	M ≤ 3.0 0.16 [0.10-0.20]	—	—	—					
●●● X VP15TF M ≤ 3.0 0.13 [0.10-0.15]			M ≤ 3.0 0.13 [0.10-0.15]	M ≤ 3.0 0.13 [0.10-0.15]	—	—	—					
Inox à durcissement structural (PH)	<450HB	●●● X MP7130 M ≤ 2.0 0.13 [0.10-0.15]	—	—	—	—	—					
		●●● X VP15TF M ≤ 2.0 0.16 [0.10-0.20]	—	—	—	—	—					
		●●● X MP7130 M ≤ 2.0 0.13 [0.10-0.15]	—	—	—	—	—					
		●●● X VP15TF M ≤ 2.0 0.13 [0.10-0.15]	—	—	—	—	—					
K	Fonte grise	≤350MPa	●●● X MC5020 M ≤ 3.0 0.13 [0.10-0.15]	M ≤ 3.0 0.13 [0.10-0.15]	M ≤ 3.0 0.13 [0.10-0.15]	M ≤ 2.0 0.13 [0.10-0.15]						
			●●● X VP15TF R ≤ 3.0 0.16 [0.10-0.20]	R ≤ 3.0 0.16 [0.10-0.20]	R ≤ 3.0 0.16 [0.10-0.20]	—	—	—				
			●●● X MC5020 R ≤ 3.0 0.13 [0.10-0.15]	R ≤ 3.0 0.13 [0.10-0.15]	R ≤ 3.0 0.13 [0.10-0.15]	R ≤ 2.0 0.13 [0.10-0.15]						
			●●● X VP15TF R ≤ 3.0 0.13 [0.10-0.15]	R ≤ 3.0 0.13 [0.10-0.15]	R ≤ 3.0 0.13 [0.10-0.15]	R ≤ 2.0 0.13 [0.10-0.15]						
	Fonte ductile	≤800MPa	●●● X MC5020 M ≤ 3.0 0.13 [0.10-0.15]	M ≤ 3.0 0.13 [0.10-0.15]	M ≤ 3.0 0.13 [0.10-0.15]	M ≤ 2.0 0.13 [0.10-0.15]						
			●●● X VP15TF R ≤ 3.0 0.16 [0.10-0.20]	R ≤ 3.0 0.16 [0.10-0.20]	R ≤ 3.0 0.16 [0.10-0.20]	—	—	—				
N	Alliage d'aluminium	Si<5%	●●● X TF15 L ≤ 2.0 0.13 [0.10-0.15]	L ≤ 2.0 0.13 [0.10-0.15]	L ≤ 2.0 0.13 [0.10-0.15]	L ≤ 2.0 0.13 [0.10-0.15]						
			●●● X TF15 L ≤ 3.0 0.13 [0.10-0.15]	L ≤ 3.0 0.13 [0.10-0.15]	L ≤ 3.0 0.13 [0.10-0.15]	—	—	—				
S	Alliage de titane	—	●●● X MP9120 M ≤ 2.0 0.10 [0.05-0.13]	—	—	—						
			●●● X MP9130 M ≤ 2.0 0.10 [0.05-0.13]	—	—	—	—					
	Alliage réfractaire	—	●●● X MP9120 M ≤ 2.0 0.10 [0.05-0.13]	—	—	—						
			●●● X MP9130 M ≤ 2.0 0.10 [0.05-0.13]	—	—	—	—					
H	Acier traité	40 - 55HRC	●●● X VP15TF M ≤ 2.0 0.05 [0.05-0.10]	—	—	—						
			●●● X VP15TF R ≤ 2.0 0.05 [0.05-0.10]	—	—	—	—					
			●●● X MP6120 R ≤ 2.0 0.05 [0.05-0.10]	—	—	—	—					

AXD

FRAISE MULTIFONCTIONS POUR L'USINAGE À GRANDE VITESSE DES ALLIAGES D'ALUMINIUM

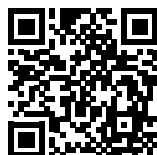
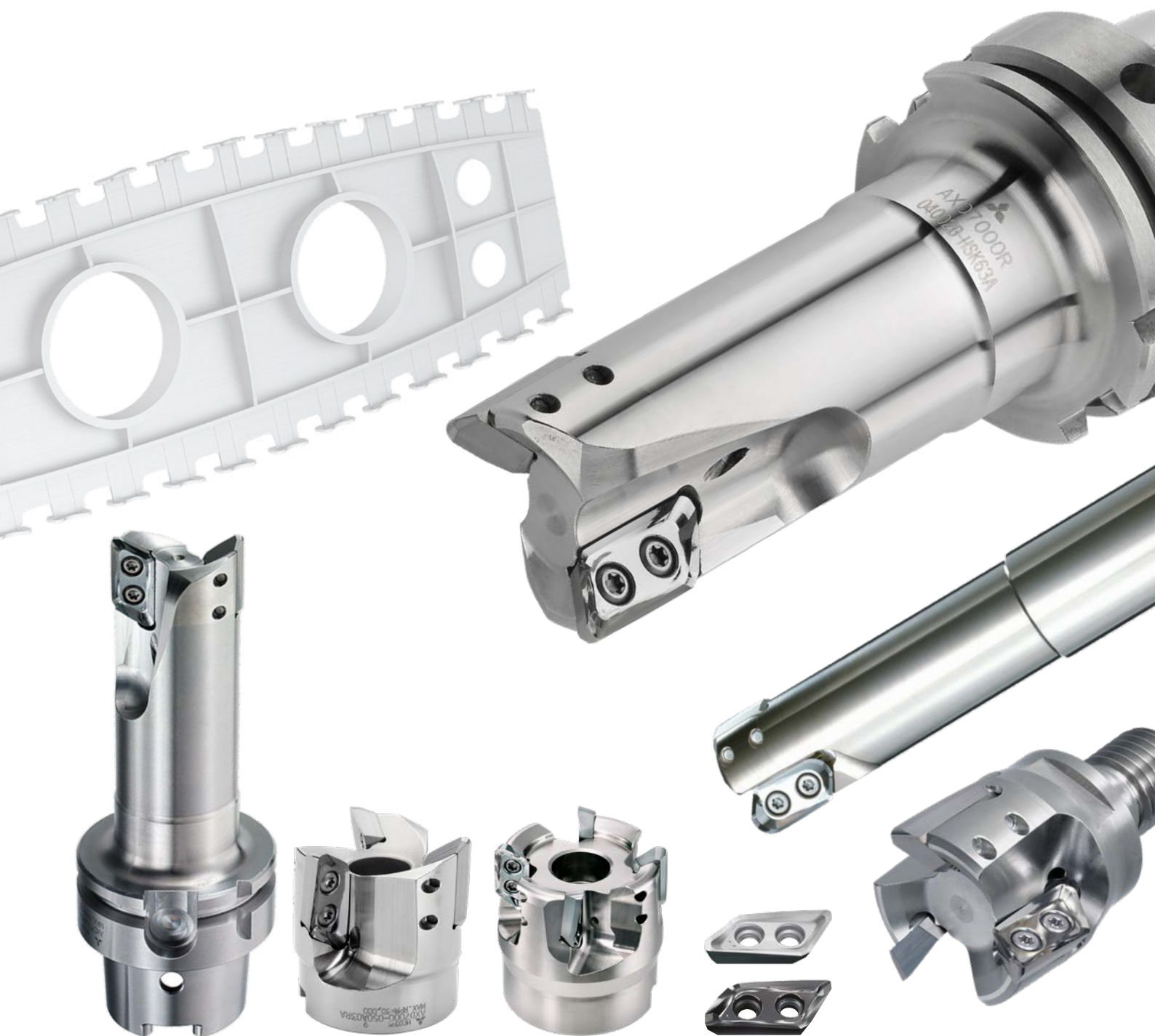

En savoir plus...

B116

www.mhg-mediastore.net



DIA EDGE

AXD4000



ATTACHEMENT PAR ALÉSAGE

N **S**



C H :0°
 A.R :+14°-15°
 R.R :+21°-+26°

 T :+21°-+26°
 I :+14°-+15°

1
Ø40

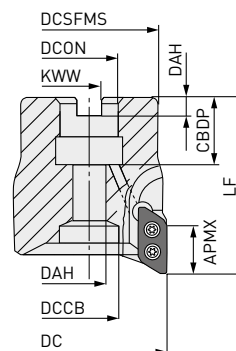

2

Ø50
 Ø63
 Ø80
 Ø100

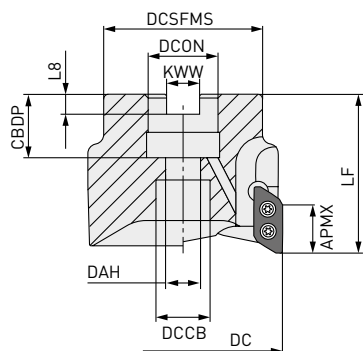

3

Ø125

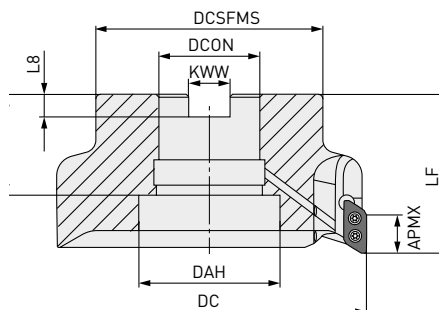

Porte-outil à droite uniquement.

DC	Vis d'attachement	Géométrie	
Ø40	HFF08043H	1	
Ø50, Ø63	HSC10030H		
Ø80	12035H		2
Ø100	16040H		2
Ø125	MBA20040H	3	

Référence	Stock	APMX	DC	DCON	LF	RPMX	WT	ZEPF	Type	RE
TYPE A										
AXD4000-040A02RA	★	15.5	40	16	50	41000	0.3	2	1	
AXD4000-040A03RA	●	15.5	40	16	50	41000	0.3	3	1	
AXD4000-050A02RA	★	15.5	50	22	50	35000	0.4	2	2	
AXD4000-050A04RA	●	15.5	50	22	50	35000	0.4	4	2	0.4
AXD4000A-050A04RD	●	15.5	50	22	50	34000	0.4	4	2	-
AXD4000-063A05RA	●	15.5	63	22	50	30000	0.6	5	2	3.2
AXD4000-080A05RA	●	15.5	80	27	50	27000	1.0	5	2	
AXD4000-100A06RA	●	15.5	100	32	63	23000	2.0	6	2	
AXD4000-125B07RA	●	15.5	125	40	63	20000	2.8	7	3	

AXD4000 – ATTACHEMENT PAR ALÉSAGE

Référence	Stock	APMX	DC	DCON	LF	RPMX	WT	ZEFP	Type	RE
TYPE B										
AXD4000-40A02RB	★	14.8	40	16	50	41000	0.3	2	1	4.0 - 5.0
AXD4000-40A03RB	●	14.8	40	16	50	41000	0.3	3	1	
AXD4000-50A02RB	★	14.8	50	22	50	35000	0.4	2	2	
AXD4000-50A04RB	●	14.8	50	22	50	35000	0.4	4	2	
AXD4000A-050A04RE	●	14.8	50	22	50	34000	0.4	4	2	
AXD4000-63A05RB	●	14.8	63	22	50	30000	0.6	5	2	
AXD4000-80A05RB	●	14.8	80	27	50	27000	1.0	5	2	
AXD4000-100A06RB	●	14.8	100	32	63	23000	2.0	6	2	
AXD4000-125B07RB	●	14.8	125	40	63	20000	2.8	7	3	

1. Les vitesses de rotation de broche maximales admissibles ont été calculées pour garantir la stabilité de l'outil et de la plaquette.
2. A haute vitesse de rotation, nous conseillons un équilibrage fin de l'ensemble attachement - corps - plaquettes.
3. Nota : Pour les plaquettes de rayon 1.6 et au-delà, les dimensions LF et LH diminuent proportionnellement à l'augmentation du rayon.
4. Les vis de serrage sont des composants importants pour la sécurité. Utilisez les vis de serrage portant la référence correcte. Si la vitesse de la broche est égale ou supérieure aux valeurs reprises dans le Tableau 2, nous vous recommandons de remplacer les vis de serrage par des vis neuves lorsque vous changez les plaquettes amovibles.



DIMENSIONS DE MONTAGE

Référence	CBDP	DAH	DCSFMS	KWW	L8	DCCB
TYPE A						
AXD4000-040A02RA	18	8.5	34	8.4	5.6	12
AXD4000-040A03RA	18	8.5	34	8.4	5.6	12
AXD4000-050A02RA	20	11	45	10.4	6.3	17
AXD4000-050A04RA	20	11	45	10.4	6.3	17
AXD4000A-050A04RD	20	11	45	10.4	6.6	17
AXD4000-063A05RA	20	11	50	10.4	6.3	17
AXD4000-080A05RA	23	13	60	12.4	7	20
AXD4000-100A06RA	26	17	78	14.4	8	26
AXD4000-125B07RA	40	56	90	16.4	9	—
TYPE B						
AXD4000-40A02RB	18	8.5	34	8.4	5.6	12
AXD4000-40A03RB	18	8.5	34	8.4	5.6	12
AXD4000-50A02RB	20	11	45	10.4	6.3	17
AXD4000-50A04RB	20	11	45	10.4	6.3	17
AXD4000A-050A04RE	20	11	45	10.4	6.3	17
AXD4000-63A05RB	20	11	50	10.4	6.3	17
AXD4000-80A05RB	23	13	60	12.4	7	20
AXD4000-100A06RB	26	17	78	14.4	8	26
AXD4000-125B07RB	40	56	90	16.4	9	—

AXD4000



FRAISE À EMBOUT FILETÉ

N

S



1

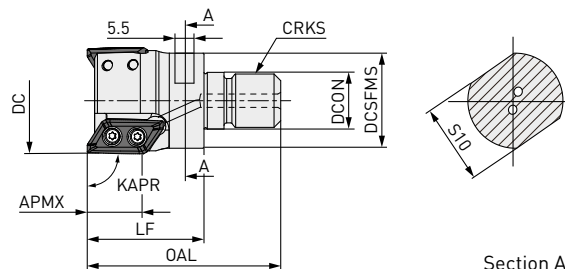

Section A-A

Porte-outil à droite uniquement.

Référence	Stock	APMX	DC	DCON	LF	OAL	RPMX	WT	ZEFP	Type	RE
TYPE A											
AXD4000R252AM1228A	●	15.0	25	12.5	28	50	49000	0.06	2	1	
AXD4000R282AM1228A	●	15.0	28	12.5	28	50	48500	0.07	2	1	
AXD4000R322AM1635A	●	15.0	32	17.0	35	58	48000	0.15	2	1	0.4-3.2
AXD4000R353AM1635A	●	15.0	35	17.0	35	58	41000	0.15	3	1	
AXD4000R403AM1635A	●	15.0	40	17.0	35	58	38000	0.18	3	1	
TYPE B											
AXD4000R252AM1228B	●	14.8	25	12.5	28	50	49000	0.06	2	1	
AXD4000R282AM1228B	●	14.8	28	12.5	28	50	48500	0.07	2	1	
AXD4000R322AM1635B	●	14.8	32	17.0	35	58	48000	0.15	2	1	4.0-5.0
AXD4000R353AM1635B	●	14.8	35	17.0	35	58	41000	0.15	3	1	
AXD4000R403AM1635B	●	14.8	40	17.0	35	58	38000	0.18	3	1	

126

DIMENSIONS DE MONTAGE

Référence	CRKS	S10	DCON	DCSFMS
TYPE A				
AXD4000R252AM1228A	M12	19	12.5	23.5
AXD4000R282AM1228A	M12	19	12.5	23.5
AXD4000R322AM1635A	M16	24	17.0	28.5
AXD4000R353AM1635A	M16	24	17.0	28.5
AXD4000R403AM1635A	M16	24	17.0	28.5
TYPE B				
AXD4000R252AM1228B	M12	19	12.5	23.5
AXD4000R282AM1228B	M12	19	12.5	23.5
AXD4000R322AM1635B	M16	24	17.0	28.5
AXD4000R353AM1635B	M16	24	17.0	28.5
AXD4000R403AM1635B	M16	24	17.0	28.5

AXD4000

CLEF DE SERRAGE VENDUE SÉPARÉMENT

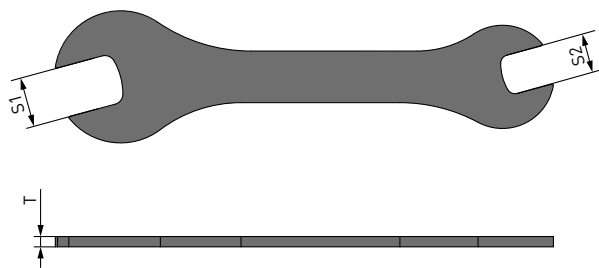

Référence	S1*	S2*	T
AKY1924050A	24	19	5

* Couple de serrage : S = 19 : 80 Nm ; S = 24 : 90 Nm

1. La largeur des plats de serrage nécessite une clef spécifique; veuillez la commander séparément du corps de fraise.

AXD4000



ATTACHEMENT CYLINDRIQUE

N S

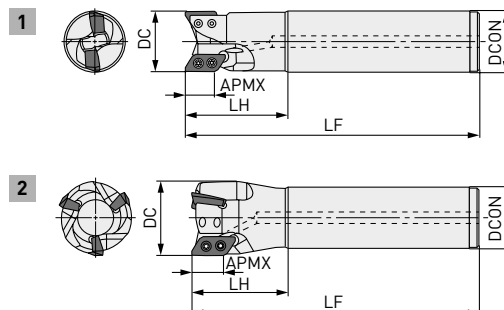

Porte-outil à droite uniquement.

Référence	Stock	APMX	DC	DCON	LF	LH	RPMX	ZEFP	Type	RE
TYPE A										
AXD4000R201SA20SA	●	15.5	20	20	110	35	15000	1	1	
AXD4000R252SA25SA	●	15.5	25	25	125	50	49000	2	1	
AXD4000R252SA25LA	●	15.5	25	25	170	80	49000	2	1	
AXD4000R282SA25SA	●	15.5	28	25	125	50	48500	2	2	
AXD4000R282SA25ELA	●	15.5	28	25	220	50	48500	2	2	
AXD4000R322SA32SA	●	15.5	32	32	150	50	48000	2	1	0.4
AXD4000R322SA32LA	●	15.5	32	32	200	80	48000	2	1	3.2
AXD4000R352SA32SA	●	15.5	35	32	150	50	45000	2	2	
AXD4000R352SA32ELA	●	15.5	35	32	250	50	45000	2	2	
AXD4000R403SA32SA	●	15.5	40	32	150	50	41000	3	2	
AXD4000R403SA42SA	●	15.5	40	42	170	80	41000	3	1	
AXD4000R403SA32ELA	●	15.5	40	32	250	50	41000	3	2	
TYPE B										
AXD4000R201SA20SB	●	14.8	20	20	110	35	15000	1	1	
AXD4000R252SA25SB	●	14.8	25	25	125	50	49000	2	1	
AXD4000R252SA25LB	●	14.8	25	25	170	80	49000	2	1	
AXD4000R282SA25SB	●	14.8	28	25	125	50	48500	2	2	
AXD4000R282SA25ELB	●	14.8	28	25	220	50	48500	2	2	
AXD4000R322SA32SB	●	14.8	32	32	150	50	48000	2	1	4.0
AXD4000R322SA32LB	●	14.8	32	32	200	80	48000	2	1	5.0
AXD4000R352SA32SB	●	14.8	35	32	150	50	45000	2	2	
AXD4000R352SA32ELB	●	14.8	35	32	250	50	45000	2	2	
AXD4000R403SA32SB	●	14.8	40	32	150	50	41000	3	2	
AXD4000R403SA42SB	●	14.8	40	42	170	80	41000	3	1	
AXD4000R403SA32ELB	●	14.8	40	32	250	50	41000	3	2	

1. La vitesse de rotation maximale admissible a été calculée pour garantir la stabilité de l'outil et de la plaquette.

2. A haute vitesse de rotation, nous conseillons un équilibrage fin de l'ensemble attachement - corps - plaquettes.





3. Nota : Pour les plaquettes de rayon 1.6 et au-delà, les dimensions LF et LH diminuent proportionnellement à l'augmentation du rayon.



AXD4000

PLAQUETTES

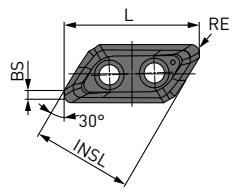
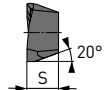

N	Alliage d'aluminium	✦	●	●	Conditions d'utilisation :
S	Alliage de titane	✦	●		●: Coupe stable ●: Coupe générale ✦: Coupe instable Honing : F : Arête vive ; E : Arrondi

Référence	Classe	Arête	revêtu		poli		L	INSL	S	BS	RE	Form	Géométrie
			LC15TF	MP9120	MT2010	TF15							
XDGX175004PDFR-GL	G	F	★			●	23.0	17.5	5	1.7	0.4		
XDGX175008PDFR-GL	G	F	★			●	23.0	17.5	5	1.3	0.8		
XDGX175012PDFR-GL	G	F	★			★	23.0	17.5	5	0.9	1.2		
XDGX175016PDFR-GL	G	F	★			●	22.0	17.5	5	1.4	1.6		
XDGX175020PDFR-GL	G	F	★			●	22.0	17.5	5	1.0	2.0		
XDGX175024PDFR-GL	G	F	★			★	22.0	17.5	5	0.6	2.4		
XDGX175030PDFR-GL	G	F	★			●	21.1	17.5	5	0.8	3.0		
XDGX175032PDFR-GL	G	F	★			★	21.1	17.5	5	0.6	3.2		
XDGX175040PDFR-GL	G	F	★			●	20.0	17.5	5	0.8	4.0		
XDGX175050PDFR-GL	G	F	★			●	19.4	17.5	5	0.4	5.0		
XDGX175004PDER-GM	G	E		●			23.0	17.5	5	1.7	0.4		
XDGX175008PDER-GM	G	E		●			23.0	17.5	5	1.3	0.8		
XDGX175012PDER-GM	G	E		●			23.0	17.5	5	0.9	1.2		
XDGX175016PDER-GM	G	E		●			22.0	17.5	5	1.4	1.6		
XDGX175020PDER-GM	G	E		●			22.0	17.5	5	1.0	2.0		
XDGX175024PDER-GM	G	E		●			22.0	17.5	5	0.6	2.4		
XDGX175030PDER-GM	G	E		●			21.1	17.5	5	0.8	3.0		
XDGX175032PDER-GM	G	E		●			21.1	17.5	5	0.6	3.2		
XDGX175040PDER-GM	G	E		●			20.0	17.5	5	0.5	4.0		
XDGX175050PDER-GM	G	E		●			19.4	17.5	5	0.4	5.0		
XDGX175004PDFR-GM	G	F			●	●	23.0	17.5	5	1.7	0.4		
XDGX175008PDFR-GM	G	F			●	●	23.0	17.5	5	1.3	0.8		
XDGX175012PDFR-GM	G	F			★	●	23.0	17.5	5	0.9	1.2		
XDGX175016PDFR-GM	G	F			●	●	22.0	17.5	5	1.4	1.6		
XDGX175020PDFR-GM	G	F			●	●	22.0	17.5	5	1.0	2.0		
XDGX175024PDFR-GM	G	F			★	●	22.0	17.5	5	0.6	2.4		
XDGX175030PDFR-GM	G	F			●	●	21.1	17.5	5	0.8	3.0		
XDGX175032PDFR-GM	G	F			★	●	21.1	17.5	5	0.6	3.2		
XDGX175040PDFR-GM	G	F			●	●	20.0	17.5	5	0.5	4.0		
XDGX175050PDFR-GM	G	F			●	●	19.4	17.5	5	0.4	5.0		

126 

PIÈCES DÉTACHÉES

ATTACHEMENT PAR ALÉSAGE / FRAISE À EMBOUT FILETÉ / ATTACHEMENT CYLINDRIQUE

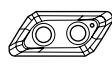
Outil	 *			
	Vis de serrage	Clé	Lubrifiant antigrippant	Plaquette
AXD4000R201SA20SA	TS3SBS	TKY08D	MK1KS	XDGX1750○○ PDR-○○
AXD4000R201SA20SB				
TYPE A	TS3SB	TKY08D	MK1KS	XDGX1750○○ PDR-○○
TYPE B				
AXD4000A	TPS3SB			

* Couple de serrage TS3BS(S) : 1.5 Nm, TPS3SB = 3.0

● : Article stocké. ★ : Article stocké au Japon.

AXD4000

COMBINAISON PORTE-OUTIL ET RAYON DE PLAQUETTE

	Corps type A								Corps type B	
	AXD4000-○○○○○○○○A AXD4000R○○○○○○○○A								AXD4000-○○○○○○○○B AXD4000R○○○○○○○○B	
Rayon de plaquette applicable R (RE)	R0.4	R0.8	R1.2	R1.6	R2.0	R2.4	R3.0	R3.2	R4.0	R5.0
	XDGX	XDGX	XDGX	XDGX	XDGX	XDGX	XDGX	XDGX	XDGX	XDGX
	175004PD-R-○○	175008PD-R-○○	175012PD-R-○○	175016PD-R-○○	175020PD-R-○○	175024PD-R-○○	175030PD-R-○○	175032PD-R-○○	175040PD-R-○○	175050PD-R-○○

1. Il est à noter que la plaquette pour le porte-outil de type A et la plaquette pour le porte-outil de type B ne sont pas compatibles.

CONDITIONS DE COUPE RECOMMANDÉES

Matière à usiner	Dureté	Nuance		Vc	ae	ap	fz						
							DC						
							Ø20	Ø25-Ø28	Ø32-Ø35	Ø40	Ø50-Ø125		
Alliage d'aluminium (A6061, A7075)	Si<5%	TF15 LC15TF	GL	1000 (200-3000)			<0.25 DC	<5	<0.05	<0.25	<0.25	<0.25	<0.25
								<10	<0.05	<0.2	<0.2	<0.2	<0.2
								<14.5	<0.05	<0.15	<0.15	<0.15	<0.15
							<0.5 DC	<5	<0.05	<0.25	<0.25	<0.25	<0.25
								<10	—	<0.2	<0.2	<0.2	<0.2
								<14.5	—	<0.15	<0.15	<0.15	<0.15
							<0.75 DC	<5	<0.05	<0.25	<0.25	<0.25	<0.25
								<10	—	<0.2	<0.2	<0.2	<0.2
								<14.5	—	<0.15	<0.15	<0.15	<0.15
							DC	<5	<0.05	<0.25	<0.25	<0.25	<0.25
								<10	—	—	—	—	—
								<14.5	—	—	—	—	—
Alliage d'aluminium (A6061, A7075)	Si<5%	TF15 MP9120	GM	1000 (200-3000)			<0.25 DC	<5	<0.05	<0.35	<0.35	<0.4	<0.4
								<10	<0.05	<0.3	<0.3	<0.35	<0.35
								<14.5	<0.05	<0.25	<0.25	<0.3	<0.3
							<0.5 DC	<5	<0.05	<0.35	<0.35	<0.35	<0.4
								<10	—	<0.3	<0.3	<0.3	<0.35
								<14.5	—	<0.2	<0.25	<0.25	<0.3
							<0.75 DC	<5	<0.05	<0.3	<0.3	<0.3	<0.35
								<10	—	<0.25	<0.25	<0.25	<0.3
								<14.5	—	<0.2	<0.2	<0.2	<0.25
							DC	<5	<0.05	<0.25	<0.25	<0.3	<0.35
								<10	—	—	—	—	—
								<14.5	—	—	—	—	—
Alliage d'aluminium (AC4B) Alliage d'aluminium (ADC12, A390)	5%≤Si≤10% Si>10%	MP9120	GM	200 (200-3000)			<0.25 DC	<5	<0.05	<0.35	<0.35	<0.4	<0.4
								<10	<0.05	<0.3	<0.3	<0.35	<0.35
								<14.5	<0.05	<0.25	<0.25	<0.3	<0.3
							<0.5 DC	<5	<0.05	<0.35	<0.35	<0.35	<0.4
								<10	—	<0.3	<0.3	<0.3	<0.35
								<14.5	—	<0.2	<0.25	<0.25	<0.3
							<0.75 DC	<5	<0.05	<0.3	<0.3	<0.3	<0.35
								<10	—	<0.25	<0.25	<0.25	<0.3
								<14.5	—	<0.2	<0.2	<0.2	<0.25
							DC	<5	<0.05	<0.25	<0.25	<0.3	<0.35
								<10	—	—	—	—	—
								<14.5	—	—	—	—	—

AXD4000

Matière à usiner	Dureté	Nuance		Vc	ae	ap	fz						
							DC						
							Ø20	Ø25-Ø28	Ø32-Ø35	Ø40	Ø50-Ø125		
S Alliage de titane (TA6V)		MP9120	GM	40 (30-60)			<0.25 DC	<5	<0.05	<0.1	<0.1	<0.1	<0.1
								<10	<0.05	<0.1	<0.1	<0.1	<0.1
								<14.5	<0.05	<0.1	<0.1	<0.1	<0.1
							<0.5 DC	<5	<0.05	<0.08	<0.1	<0.1	<0.1
								<10	—	<0.08	<0.1	<0.1	<0.1
								<14.5	—	<0.08	<0.1	<0.1	<0.1
							<0.75 DC	<5	<0.05	<0.05	<0.08	<0.1	<0.1
								<10	—	<0.05	<0.08	<0.1	<0.1
								<14.5	—	<0.05	<0.08	<0.1	<0.1
							DC	<5	<0.05	<0.05	<0.05	<0.05	<0.05
								<10	—	—	—	—	—
								<14.5	—	—	—	—	—

1. Les conditions de coupe déterminées ci-dessus se basent sur des machines et des pièces de grande rigidité, sans aucune vibration. Si des vibrations surviennent, veuillez procéder aux réglages en fonction des conditions d'usinage.
2. Veuillez noter qu'il est possible que des vibrations apparaissent dans les conditions suivantes.
Lorsque vous utilisez l'outil avec un porte-à-faux important.
Lors de l'usinage dans les rayons des poches
Lorsque la rigidité de serrage de la pièce est faible ou lorsque la machine ou la pièce est peu rigide, des vibrations peuvent apparaître facilement. Dans ce cas, veuillez réduire les conditions de coupe telles que la largeur et la profondeur de coupe, ainsi que l'avance par dent.

AXD4000A

Matière à usiner	Dureté	Nuance		Vc	ae	ap	fz			
							DC			
							Ø50			
N Alliage d'aluminium (A7050, A7075, A2024, A6061)	Si<5%	MT2010 TF15 MP9120	GM	4000 (200-5000)			≤5	≤ 0.35		
							≤0.5 D1	≤10	≤ 0.30	
								≤14.5	≤ 0.25	
								≤5	≤ 0.30	
		TF15 LC15TF	GL	4000 (200-5000)				≤0.75 D1	≤10	≤ 0.25
									≤14.5	≤ 0.20
								D1	≤5	≤ 0.30
									≤5	≤ 0.20
D1		≤0.75 D1		≤10	≤ 0.15					
				≤14.5	≤ 0.10					
				D1		≤5	≤ 0.20			

1. Les conditions de coupe déterminées ci-dessus se basent sur des machines et des pièces de grande rigidité, sans aucune vibration. Si des vibrations surviennent, veuillez procéder aux réglages en fonction des conditions d'usinage.
2. Veuillez noter qu'il est possible que des vibrations apparaissent dans les conditions suivantes.
Lorsque vous utilisez l'outil avec un porte-à-faux important.
Lors de l'usinage dans les rayons des poches.
Lorsque la rigidité de serrage de la pièce est faible ou lorsque la machine ou la pièce est peu rigide, des vibrations peuvent apparaître facilement. Dans ce cas, veuillez réduire les conditions de coupe telles que la largeur et la profondeur de coupe, ainsi que l'avance par dent.

AXD4000

RAMPING / FRAISAGE HÉLICOÏDAL

1 Ramping

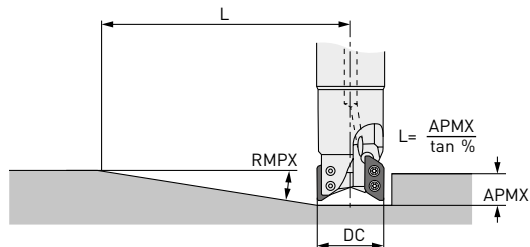

2 Fraisage hélicoïdal

2.1 Trous borgnes, Fond plat

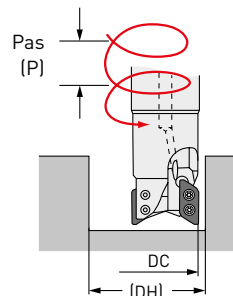

2.2 Trous débouchants

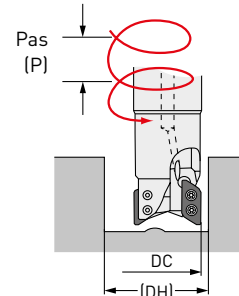

DC	RE	1		2.1				2.2	
		RMPX	L*1	DH max.	P max.	DH min.	P max.	DH min.	P max.
TYPE A									
20	0.4-1.2	20.7	42	37.1 *2	14	36.1	14	22	2
	1.6-2.4	19.9	43	34.7 *3	13	34.6	13	22	2
	3.0-3.2	18.9	46	33.1 *4	12	33.3	12	22	1
25	0.4-1.2	23.1	37	47.1 *2	14	46	14	32	8
	1.6-2.4	22.0	39	44.7 *3	13	44.4	13	32	8
	3.0-3.2	18.7	46	43.1 *4	12	43	12	32	7
28	0.4-1.2	19.2	45	53.1 *2	14	52	14	36	8
	1.6-2.4	18.5	47	50.7 *3	13	50.4	13	36	8
	3.0-3.2	16.7	52	49.1 *4	12	48.9	12	36	7
32	0.4-1.2	15.4	57	61.1 *2	14	59.9	14	46	11
	1.6-2.4	14.7	60	58.7 *3	13	58.3	13	46	11
	3.0-3.2	13.8	64	57.1 *4	12	56.8	12	46	10
35	0.4-1.2	13.4	66	67.1 *2	14	65.8	14	50	11
	1.6-2.4	12.7	69	64.7 *3	13	64.3	13	50	10
	3.0-3.2	11.8	75	63.1 *4	12	62.8	12	50	9
40	0.4-1.2	11.1	80	76.7 *2	14	75.9	14	62	13
	1.6-2.4	10.4	85	74.3 *3	13	74.2	13	62	12
	3.0-3.2	9.7	91	72.7 *4	12	72.7	12	62	11
50	0.4-1.2	8.2	108	96.7 *2	14	95.6	14	81	14
	1.6-2.4	7.6	117	94.3 *3	13	94	13	81	13
	3.0-3.2	6.9	129	92.7 *4	12	92.4	12	81	11
63	0.4-1.2	6.1	146	122.7 *2	14	121.6	14	107	14
	1.6-2.4	5.6	159	120.3 *3	13	119.9	13	107	13
	3.0-3.2	5.2	171	118.7 *4	12	118.4	12	107	12
80	0.4-1.2	4.6	193	156.7 *2	14	155.6	14	141	14
	1.6-2.4	4.2	212	154.3 *3	13	153.9	13	141	13
	3.0-3.2	3.8	234	152.7 *4	12	152.4	12	141	12
100	0.4-1.2	3.5	254	196.7 *2	14	195.5	14	181	14
	1.6-2.4	3.2	278	194.3 *3	13	193.9	13	181	13
	3.0-3.2	2.9	306	192.7 *4	12	192.3	12	181	12
125	0.4-1.2	2.7	329	246.7 *2	14	245.5	14	231	14
	1.6-2.4	2.5	356	244.3 *3	13	243.8	13	231	13
	3.0-3.2	2.3	386	242.7 *4	12	242.3	12	231	12

AXD4000 – RAMPING / FRAISAGE HÉLICOÏDAL

DC	RE	1		2.1				2.2	
		RMPX	L*1	DH max.	P max.	DH min.	P max.	DH min.	P max.
TYPE B									
20	4	17.5	47	31.5	10	31.8	10	22	1
	5	16.6	71	29.5	6	31.1	7	22	1
25	4	15.1	55	41.5	10	41.4	10	32	5
	5	13.7	61	39.5	9	40.6	9	32	5
28	4	14.1	59	47.5	10	47.2	10	36	6
	5	13	65	45.5	9	46.4	9	36	5
32	4	12.7	66	55.5	10	55.1	10	46	9
	5	12	70	53.5	9	54.3	9	46	8
35	4	10.8	78	61.5	10	61	10	50	8
	5	10.2	83	59.5	9	60.2	9	50	8
40	4	8.8	96	71.1	10	70.9	10	62	10
	5	8.2	103	69.1	9	70.1	9	62	9
50	4	6.3	135	91.1	10	90.6	10	81	10
	5	5.8	146	89.1	9	89.8	9	81	9
63	4	4.6	184	117.1	10	116.6	10	107	10
	5	4.2	202	115.1	9	115.7	9	107	9
80	4	3.4	250	151.1	10	150.5	10	141	10
	5	3.1	274	149.1	9	149.6	9	141	9
100	4	2.6	326	191.1	10	190.5	10	181	10
	5	2.4	354	189.1	9	189.6	9	181	9
125	4	2	424	241.1	10	240.5	10	231	10
	5	1.8	471	239.1	9	239.6	9	231	9

1. L'avance en ramping recommandée est 0.05 mm/dent ou moins.

*1 En utilisant l'angle de ramping maximum, la distance pour atteindre la profondeur de coupe maximale est la suivante :
 $L = (\text{profondeur de coupe maximale APMX} / \tan \%)$. La profondeur de coupe maximale type A est de 15.5 mm, et de 14.8 mm pour le type B

*2 Rayon de pointe de 1.2 mm. Pour les autres rayons de pointe, veuillez utiliser la formule suivante :
 $\{(DC) - (RE) - 0.25\} \times 2$

*3 Rayon de pointe de 2.4 mm. Pour les autres rayons de pointe, veuillez utiliser la formule suivante :
 $\{(DC) - (RE) - 0.25\} \times 2$

*4 Rayon de pointe de 3.2 mm. Pour les autres rayons de pointe, veuillez utiliser la formule suivante :
 $\{(DC) - (RE) - 0.25\} \times 2$

PROFONDEUR MAXIMALE DE PERÇAGE

	RE	DC					
		Ø20	Ø25	Ø28	Ø32	Ø35	Ø40-Ø125
Type A	0.4	5.3	5.2	5.2	5.2	5.3	5.3
	0.8	5.3	5.2	5.2	5.2	5.3	5.3
	1.2	5.3	5.2	5.2	5.2	5.3	5.3
	1.6	4.8	4.6	4.7	4.7	4.9	4.8
	2.0	4.8	4.6	4.7	4.7	4.9	4.8
	2.4	4.8	4.6	4.7	4.7	4.9	4.8
	3.0	4.3	3.7	4.2	4.2	4.4	4.4
	3.2	4.3	3.7	4.2	4.2	4.4	4.4
Type B	4.0	3.7	2.7	3.7	3.6	3.8	3.8
	5.0	3.4	2.3	3.3	3.3	3.5	3.5

NEW

DFAS

FORETS CARBURE MONOBLOC À FOND PLAT
PRÉCISION ET POLYVALENCE



En savoir plus...

B233

www.mhg-mediastore.net



DFAS

POUR L'ACIER INOXYDABLE ET LE TITANE



CONTRÔLE DU COPEAU OPTIMAL ET RÉDUCTION DE LA POUSSÉE

La géométrie d'amincissement optimisée génère une faible résistance et assure un contrôle du copeau efficace, évitant ainsi tout risque de bourrage.

TECHNOLOGIE TRI-COOLING POUR TOUS LES DIAMÈTRES

Le débit d'arrosage est augmenté sans diminuer la raideur du foret. Le débit d'arrosage augmenté améliore considérablement l'évacuation des copeaux et dissipe la chaleur générée par l'usinage. Cela permet un usinage stable de l'acier inoxydable et des alliages de titane.

FORME INNOVANTE DE L'ARÊTE DE COUPE

Un renfort d'arête sur les becs évite l'écaillage surtout en coupe interrompue, tandis qu'une grande acuité d'arête empêche les bavures.

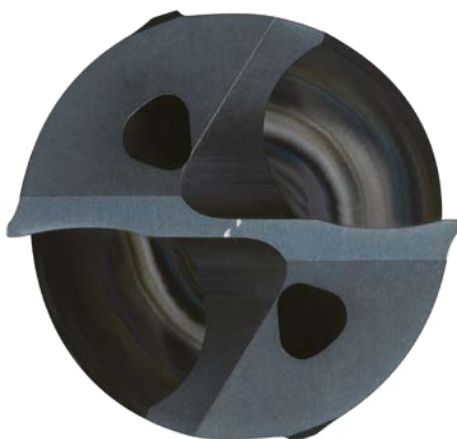

DFAS



Conventionnel

NUANCE REVÊTUE DP102A

DP102A est une nuance de carbure revêtu PVD spécifique aux forets. Le revêtement présente une adhésion et une stabilité élevées même sur une arête de grande acuité. Ce nouveau revêtement améliore grandement la résistance à l'usure. Il est idéal pour le perçage de trous de petits diamètres à des conditions de vitesse et d'avance réduites.

ACUITÉ D'ARÊTE ET GRANDE DURÉE DE VIE



Revêtement PVD de type AlCrN

Matière	Inox 304
Outil	MFE0100X02S030
L/D (mm)	2
Vc (m/min)	25
fr (mm)	0.007
Machine	CU vertical (BT40)

100 trous



DFAS



Conventionnel

500 trous



DFAS



Conventionnel

DFAS



FORETS CARBURE MONOBLOC À FOND PLAT

P M K N

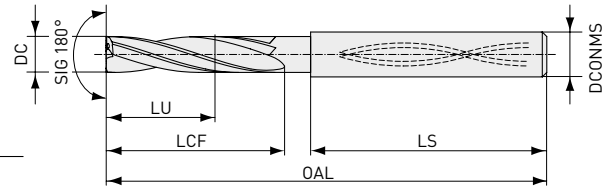

	DC=3	3 < DC<6	6 < DC<10	10 < DC<14
	0 - 0.014	0 - 0.018	0 - 0.022	0 - 0.027
	4 < DCON<6	6 < DCON<10	10 < DCON<14	
	0 - 0.008	0 - 0.009	0 - 0.011	

Référence	DP102A	DC	L/D	LU	LCF	LS	OAL	DCON
DFAS0300X03S040	●	3.0	3	9.0	14	39.0	55	4
DFAS0310X03S040	★	3.1	3	9.3	16	37.0	55	4
DFAS0320X03S040	★	3.2	3	9.6	16	37.0	55	4
DFAS0330X03S040	●	3.3	3	9.9	16	37.0	55	4
DFAS0340X03S040	★	3.4	3	10.2	16	37.0	55	4
DFAS0350X03S040	●	3.5	3	10.5	16	37.0	55	4
DFAS0360X03S040	★	3.6	3	10.8	18	35.0	55	4
DFAS0370X03S040	★	3.7	3	11.1	18	35.0	55	4
DFAS0380X03S040	★	3.8	3	11.4	18	35.0	55	4
DFAS0390X03S040	★	3.9	3	11.7	18	35.0	55	4
DFAS0400X03S040	●	4.0	3	12.0	18	35.0	55	4
DFAS0410X03S050	★	4.1	3	12.3	20	40.0	62	5
DFAS0420X03S050	●	4.2	3	12.6	20	40.0	62	5
DFAS0430X03S050	★	4.3	3	12.9	20	40.0	62	5
DFAS0440X03S050	★	4.4	3	13.2	20	40.0	62	5
DFAS0450X03S050	●	4.5	3	13.5	20	40.0	62	5
DFAS0460X03S050	★	4.6	3	13.8	23	37.0	62	5
DFAS0470X03S050	★	4.7	3	14.1	23	37.0	62	5
DFAS0480X03S050	★	4.8	3	14.4	23	37.0	62	5
DFAS0490X03S050	★	4.9	3	14.7	23	37.0	62	5
DFAS0500X03S050	●	5.0	3	15.0	23	37.0	62	5
DFAS0510X03S060	★	5.1	3	15.3	25	39.0	66	6
DFAS0520X03S060	★	5.2	3	15.6	25	39.0	66	6
DFAS0530X03S060	●	5.3	3	15.9	25	39.0	66	6
DFAS0540X03S060	★	5.4	3	16.2	25	39.0	66	6
DFAS0550X03S060	●	5.5	3	16.5	25	39.0	66	6
DFAS0560X03S060	★	5.6	3	16.8	27	37.0	66	6
DFAS0570X03S060	★	5.7	3	17.1	27	37.0	66	6
DFAS0580X03S060	★	5.8	3	17.4	27	37.0	66	6
DFAS0590X03S060	★	5.9	3	17.7	27	37.0	66	6
DFAS0600X03S060	●	6.0	3	18.0	27	37.0	66	6

DFAS - FORETS CARBURE MONOBLOC À FOND PLAT

Référence	DP102A	DC	L/D	LU	LCF	LS	OAL	DCON
DFAS0610X03S070	★	6.1	3	18.3	29	44.0	75	7
DFAS0620X03S070	★	6.2	3	18.6	29	44.0	75	7
DFAS0630X03S070	★	6.3	3	18.9	29	44.0	75	7
DFAS0640X03S070	★	6.4	3	19.2	29	44.0	75	7
DFAS0650X03S070	●	6.5	3	19.5	29	44.0	75	7
DFAS0660X03S070	★	6.6	3	19.8	32	41.0	75	7
DFAS0670X03S070	★	6.7	3	20.1	32	41.0	75	7
DFAS0680X03S070	●	6.8	3	20.4	32	41.0	75	7
DFAS0690X03S070	★	6.9	3	20.7	32	41.0	75	7
DFAS0700X03S070	●	7.0	3	21.0	32	41.0	75	7
DFAS0710X03S080	★	7.1	3	21.3	34	44.0	80	8
DFAS0720X03S080	★	7.2	3	21.6	34	44.0	80	8
DFAS0730X03S080	★	7.3	3	21.9	34	44.0	80	8
DFAS0740X03S080	★	7.4	3	22.2	34	44.0	80	8
DFAS0750X03S080	●	7.5	3	22.5	34	44.0	80	8
DFAS0760X03S080	★	7.6	3	22.8	36	42.0	80	8
DFAS0770X03S080	★	7.7	3	23.1	36	42.0	80	8
DFAS0780X03S080	★	7.8	3	23.4	36	42.0	80	8
DFAS0790X03S080	★	7.9	3	23.7	36	42.0	80	8
DFAS0800X03S080	●	8.0	3	24.0	36	42.0	80	8
DFAS0810X03S090	★	8.1	3	24.3	38	45.0	85	9
DFAS0820X03S090	●	8.2	3	24.6	38	45.0	85	9
DFAS0830X03S090	★	8.3	3	24.9	38	45.0	85	9
DFAS0840X03S090	★	8.4	3	25.2	38	45.0	85	9
DFAS0850X03S090	●	8.5	3	25.5	38	45.0	85	9
DFAS0860X03S090	★	8.6	3	25.8	41	42.0	85	9
DFAS0870X03S090	★	8.7	3	26.1	41	42.0	85	9
DFAS0880X03S090	●	8.8	3	26.4	41	42.0	85	9
DFAS0890X03S090	★	8.9	3	26.7	41	42.0	85	9
DFAS0900X03S090	●	9.0	3	27.0	41	42.0	85	9
DFAS0910X03S100	★	9.1	3	27.3	43	45.0	90	10
DFAS0920X03S100	★	9.2	3	27.6	43	45.0	90	10
DFAS0930X03S100	★	9.3	3	27.9	43	45.0	90	10
DFAS0940X03S100	★	9.4	3	28.2	43	45.0	90	10
DFAS0950X03S100	●	9.5	3	28.5	43	45.0	90	10
DFAS0960X03S100	★	9.6	3	28.8	45	43.0	90	10
DFAS0970X03S100	●	9.7	3	29.1	45	43.0	90	10
DFAS0980X03S100	★	9.8	3	29.4	45	43.0	90	10
DFAS0990X03S100	★	9.9	3	29.7	45	43.0	90	10
DFAS1000X03S100	●	10.0	3	30.0	45	43.0	90	10
DFAS1010X03S110	★	10.1	3	30.3	47	52.0	101	11
DFAS1020X03S110	●	10.2	3	30.6	47	52.0	101	11
DFAS1030X03S110	★	10.3	3	30.9	47	52.0	101	11
DFAS1040X03S110	★	10.4	3	31.2	47	52.0	101	11
DFAS1050X03S110	●	10.5	3	31.5	47	52.0	101	11
DFAS1060X03S110	★	10.6	3	31.8	50	49.0	101	11
DFAS1070X03S110	★	10.7	3	32.1	50	49.0	101	11
DFAS1080X03S110	★	10.8	3	32.4	50	49.0	101	11
DFAS1090X03S110	★	10.9	3	32.7	50	49.0	101	11
DFAS1100X03S110	●	11.0	3	33.0	50	49.0	101	11

DFAS - FORETS CARBURE MONOBLOC À FOND PLAT

Référence	DP102A	DC	L/D	LU	LCF	LS	OAL	DCON
DFAS1110X03S120	★	11.1	3	33.3	52	51.0	105	12
DFAS1120X03S120	★	11.2	3	33.6	52	51.0	105	12
DFAS1130X03S120	★	11.3	3	33.9	52	51.0	105	12
DFAS1140X03S120	★	11.4	3	34.2	52	51.0	105	12
DFAS1150X03S120	●	11.5	3	34.5	52	51.0	105	12
DFAS1160X03S120	★	11.6	3	34.8	54	49.0	105	12
DFAS1170X03S120	★	11.7	3	35.1	54	49.0	105	12
DFAS1180X03S120	★	11.8	3	35.4	54	49.0	105	12
DFAS1190X03S120	★	11.9	3	35.7	54	49.0	105	12
DFAS1200X03S120	●	12.0	3	36.0	54	49.0	105	12
DFAS1250X03S130	★	12.5	3	37.5	56	52.0	110	13
DFAS1300X03S130	●	13.0	3	39.0	59	49.0	110	13
DFAS1350X03S140	★	13.5	3	40.5	61	51.0	114	14
DFAS1400X03S140	●	14.0	3	42.0	63	49.0	114	14

DFAS

CONDITIONS DE COUPE RECOMMANDÉES

Matière	DC	L/D	n	$\alpha = 0^\circ$ fr (Min. - Max.) (mm)
Aciers doux (<180 HB) C10E etc.	0.75	≤2	23300	0.030 (0.010–0.050)
	1.0	≤2	17500	0.030 (0.010–0.050)
	1.5	≤2	12200	0.035 (0.015–0.055)
	2.0	≤2	9500	0.040 (0.020–0.060)
	2.5	≤2	7900	0.050 (0.030–0.070)
	3.0	≤2	7900	0.060 (0.040–0.080)
	4.0	≤2	5900	0.080 (0.060–0.100)
	5.0	≤2	4700	0.100 (0.080–0.130)
	6.0	≤2	3900	0.130 (0.100–0.150)
	8.0	≤2	2900	0.150 (0.130–0.170)
	10.0	≤2	2300	0.170 (0.150–0.200)
	12.0	≤2	1900	0.200 (0.170–0.250)
	16.0	≤2	1400	0.250 (0.200–0.300)
20.0	≤2	1100	0.300 (0.250–0.350)	
P Aciers carbone, aciers alliés (180 – 280 HB) XC45, 42CD4 etc.	0.75	≤2	19000	0.030 (0.010–0.050)
	1.0	≤2	14300	0.030 (0.010–0.050)
	1.5	≤2	10000	0.035 (0.015–0.055)
	2.0	≤2	7900	0.040 (0.020–0.060)
	2.5	≤2	6600	0.050 (0.030–0.070)
	3.0	≤2	7900	0.060 (0.040–0.080)
	4.0	≤2	5900	0.080 (0.060–0.100)
	5.0	≤2	4700	0.100 (0.080–0.130)
	6.0	≤2	3900	0.130 (0.100–0.150)
	8.0	≤2	2900	0.150 (0.130–0.170)
	10.0	≤2	2300	0.170 (0.150–0.200)
	12.0	≤2	1900	0.200 (0.170–0.250)
	16.0	≤2	1400	0.250 (0.200–0.300)
20.0	≤2	1100	0.300 (0.250–0.350)	
Aciers carbone, aciers alliés (280 – 350 HB) 40CND etc.	0.75	≤2	16900	0.030 (0.010–0.050)
	1.0	≤2	12700	0.030 (0.010–0.050)
	1.5	≤2	8400	0.035 (0.015–0.055)
	2.0	≤2	6700	0.040 (0.020–0.060)
	2.5	≤2	5700	0.050 (0.030–0.070)
	3.0	≤2	6800	0.060 (0.040–0.080)
	4.0	≤2	5100	0.080 (0.060–0.100)
	5.0	≤2	4100	0.100 (0.080–0.130)
	6.0	≤2	3400	0.130 (0.100–0.150)
	8.0	≤2	2500	0.150 (0.130–0.170)
	10.0	≤2	2000	0.170 (0.150–0.200)
	12.0	≤2	1700	0.200 (0.170–0.250)
	16.0	≤2	1200	0.250 (0.200–0.300)
20.0	≤2	1000	0.300 (0.250–0.350)	
M Aciers inoxydables austénitiques (<200 HB) DIN 304, 316 etc.	0.75	≤2	10600	0.007 (0.003–0.011)
	1.0	≤2	7900	0.007 (0.003–0.011)
	1.5	≤2	5300	0.010 (0.005–0.015)
	2.0	≤2	4700	0.015 (0.010–0.020)
	2.5	≤2	3800	0.015 (0.010–0.020)
	3.0	≤2	3100	0.020 (0.010–0.030)
	4.0	≤2	2300	0.030 (0.020–0.040)
	5.0	≤2	1900	0.040 (0.030–0.050)
	6.0	≤2	1500	0.050 (0.040–0.060)
	8.0	≤2	1100	0.060 (0.050–0.080)
	10.0	≤2	950	0.080 (0.060–0.100)
	12.0	≤2	790	0.100 (0.080–0.120)
	16.0	≤2	590	0.120 (0.100–0.150)
20.0	≤2	470	0.150 (0.120–0.200)	

DFAS

CONDITIONS DE COUPE RECOMMANDÉES

Matière	DC	L/D	n	$\alpha = 0^\circ$ fr (Min. - Max.) (mm)
K Fontes grises (<350 MPa) Ft30 etc.	0.75	≤ 2	23300	0.030 (0.010-0.050)
	1.0	≤ 2	17500	0.030 (0.010-0.050)
	1.5	≤ 2	12200	0.035 (0.015-0.055)
	2.0	≤ 2	9500	0.040 (0.020-0.060)
	2.5	≤ 2	7900	0.050 (0.030-0.070)
	3.0	≤ 2	7900	0.060 (0.040-0.080)
	4.0	≤ 2	5900	0.030 (0.020-0.040)
	5.0	≤ 2	4700	0.040 (0.030-0.050)
	6.0	≤ 2	3900	0.050 (0.040-0.060)
	8.0	≤ 2	2900	0.060 (0.050-0.080)
	10.0	≤ 2	2300	0.080 (0.060-0.100)
	12.0	≤ 2	1900	0.100 (0.080-0.120)
	16.0	≤ 2	1400	0.120 (0.100-0.150)
	20.0	≤ 2	1100	0.150 (0.120-0.200)
K Fontes ductiles (<450 MPa) FGS400 etc.	0.75	≤ 2	16900	0.010 (0.005-0.015)
	1.0	≤ 2	12700	0.010 (0.005-0.015)
	1.5	≤ 2	10000	0.020 (0.010-0.030)
	2.0	≤ 2	8700	0.030 (0.015-0.045)
	2.5	≤ 2	7300	0.045 (0.025-0.065)
	3.0	≤ 2	6800	0.050 (0.040-0.060)
	4.0	≤ 2	5500	0.030 (0.020-0.040)
	5.0	≤ 2	4400	0.040 (0.030-0.050)
	6.0	≤ 2	3700	0.050 (0.040-0.060)
	8.0	≤ 2	2700	0.060 (0.050-0.080)
	10.0	≤ 2	2200	0.080 (0.060-0.100)
	12.0	≤ 2	1800	0.100 (0.080-0.120)
	16.0	≤ 2	1300	0.120 (0.100-0.150)
	20.0	≤ 2	1100	0.150 (0.120-0.200)
N Alliages d'aluminium (Si <5 %) 6061, 7075 etc.	0.75	≤ 2	42400	0.020 (0.010-0.030)
	1.0	≤ 2	31800	0.020 (0.010-0.030)
	1.5	≤ 2	21200	0.020 (0.010-0.030)
	2.0	≤ 2	17500	0.050 (0.030-0.070)
	2.5	≤ 2	14000	0.060 (0.040-0.090)
	3.0	≤ 2	11600	0.060 (0.040-0.090)
	4.0	≤ 2	8700	0.080 (0.060-0.100)
	5.0	≤ 2	7000	0.100 (0.080-0.130)
	6.0	≤ 2	5800	0.130 (0.100-0.160)
	8.0	≤ 2	4300	0.160 (0.130-0.200)
	10.0	≤ 2	3500	0.200 (0.160-0.240)
	12.0	≤ 2	2900	0.240 (0.200-0.280)
	16.0	≤ 2	2100	0.280 (0.240-0.320)
	20.0	≤ 2	1700	0.320 (0.280-0.360)
S Alliage de titane (Ti-6Al-4V, Ti-5Al-5V-5Mo-3Cr)	3.0	≤ 3	3710	0.030 (0.010-0.050)
	4.0	≤ 3	2790	0.040 (0.010-0.070)
	5.0	≤ 3	2230	0.050 (0.020-0.080)
	6.0	≤ 3	1860	0.060 (0.020-0.100)
	7.0	≤ 3	1590	0.070 (0.020-0.120)
	8.0	≤ 3	1390	0.080 (0.030-0.130)
	9.0	≤ 3	1240	0.090 (0.030-0.150)
	10.0	≤ 3	1110	0.100 (0.030-0.170)
	11.0	≤ 3	1010	0.110 (0.040-0.180)
	12.0	≤ 3	930	0.120 (0.040-0.200)
	13.0	≤ 3	860	0.130 (0.040-0.220)
14.0	≤ 3	800	0.140 (0.050-0.230)	

1. La profondeur de perçage recommandée est 2 x DC. Cette profondeur est donnée depuis la hauteur supérieure lors de perçages en oblique. (reportez-vous au schéma)
2. Le tableau ci-dessus se base sur une attaque perpendiculaire sur surface plane. Pour le perçage de surfaces obliques, réduisez la vitesse d'avance en conséquence. Quand l'angle d'inclinaison α inférieur ou égal à 30° , réglez la vitesse d'avance à 70 % ou moins, lorsque l'angle d'inclinaison α est supérieur à 30° , réglez la vitesse d'avance à 50 % ou moins.
3. Cet outil est utilisable uniquement en perçage. Il ne peut pas être utilisé en fraisage (agrandissement en contournage) ou en perçage hélicoïdal.

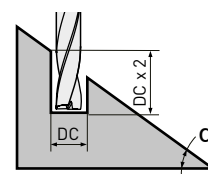

EXEMPLES D'APPLICATION

Matière	XC50
Outil	DFAS0800X03S080
Pièce	Composant de machine
Vc (m/min)	100
fr (mm)	0.12
L/D (mm)	4.5
Arrosage	Interne
Lubrifiant	Huile soluble
Machine	MC

Résultats

Le bruit de coupe a été réduit et le nombre de trous percés a augmenté de 700 % par rapport à un produit conventionnel. L'état de surface a également été amélioré.

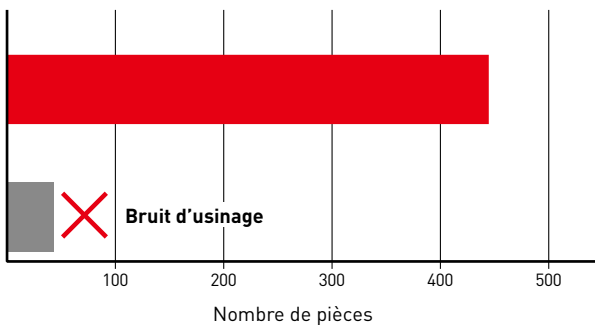
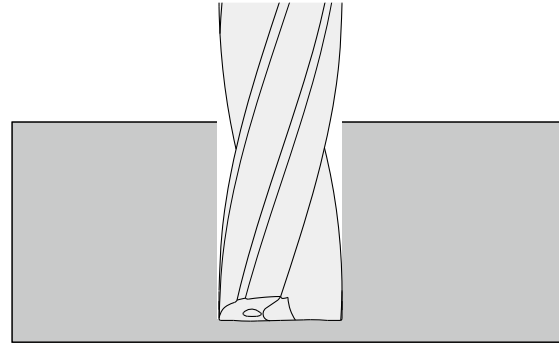

Matière	E28-2
Outil	DFAS1100X03S110
Pièce	Pièces machine
Vc (m/min)	104
fr (mm)	0.12
L/D (mm)	27
Arrosage	Interne
Lubrifiant	Huile soluble
Machine	MC

Résultats

Le bruit de coupe a été réduit et la durée de vie a été multipliée par 4 rapport à un produit conventionnel. L'état de surface a également été amélioré.

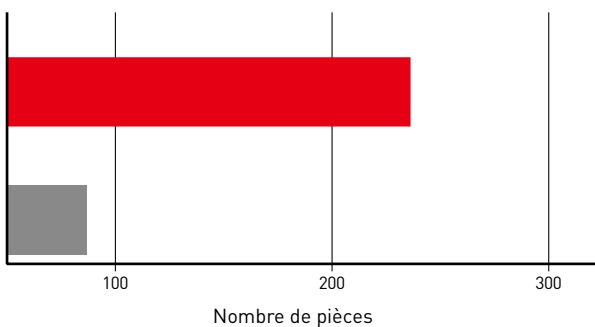
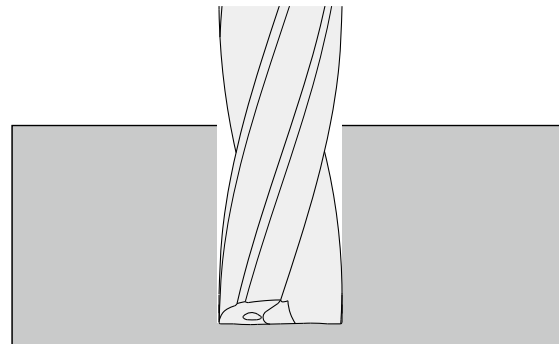

■ DFAS ■ Conventionnel

RECOMMANDATIONS D'UTILISATION

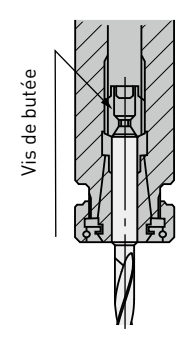
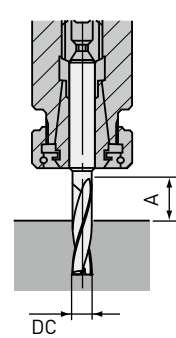
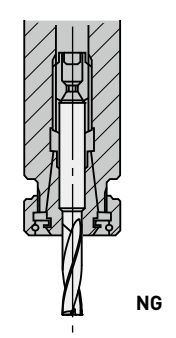
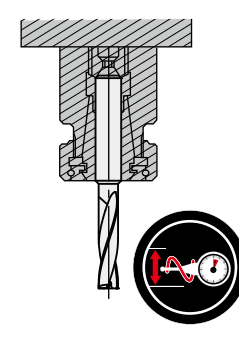
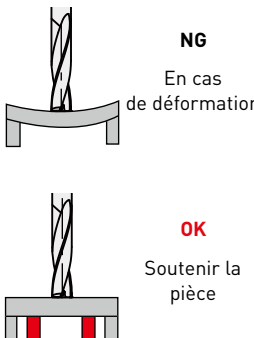
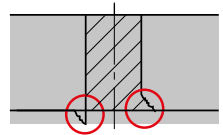
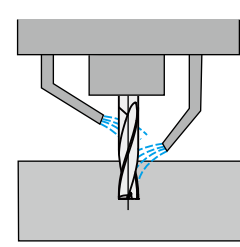
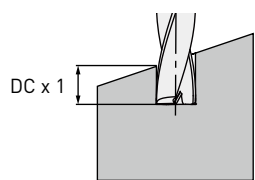
Serrage du foret	Longueur du foret	Montage du foret	Tolérance de montage
 <p>Utilisez des attachements à butée pour un maintien du foret en toute sécurité.</p>	 <p>$A > DC \times 1.5$</p>	 <p>Ne serrez pas sur les goujures.</p>	 <p>Battement < 0.03 mm</p>
 <p>NG En cas de déformation</p> <p>OK Soutenir la pièce</p>	 <p>Diminuez la vitesse d'avance de 50 % en débouchant. Prévoyez un chanfrein.</p>	 <p>Deux positions d'arrosage, idéalement à l'extrémité et au centre.</p>	 <p>Lors d'un perçage profond sur une surface oblique, utilisez un foret MFE (L/D=2) comme pilote. Percez sur environ 1xDC pour un guidage précis.</p>

NEW

415SD (MPLUS)

FRAISE À GRANDE AVANCE POUR LES ALLIAGES
DE TITANE

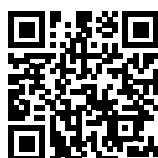

En savoir plus...

MP111

www.mhg-mediastore.net

415SD (MPLUS)

FRAISE À GRANDE AVANCE POUR L'INOX ET LE TITANE



HAUTE PERFORMANCE ET STABILITÉ VIBRATOIRE

- Le pas variable atténue les vibrations, spécialement dans les applications à grand porte-à-faux.
- Des outils à pas fin et extra-fin assurent une grande productivité.
- L'acier spécifique des corps de fraise assure une grande fiabilité et longévité des outils. Le nickelage augmente la résistance à la corrosion et à l'usure.
- Le logement de plaquette de haute précision et les buses d'arrosage contribuent largement aux performances d'usinage.

GRANDE PRODUCTIVITÉ

L'angle d'attaque de 15° permet de grandes profondeurs de passe tout en réduisant les efforts en direction radiale.

ARROSAGE PERFORMANT

Les différents diamètres de buses d'arrosage permettent de s'adapter de manière optimale aux pressions et débits d'arrosage disponibles sur la machine. L'arrosage performant assure fiabilité et durée de vie.

SÉCURITÉ, PRÉCISION ET FIABILITÉ

Le positionnement précis et le serrage fiable des plaquettes permettent d'obtenir de grandes performances de coupe et une forte productivité en toute fiabilité.



415SD (MPLUS)

PLAQUETTES À GRANDE AVANCE

LA NUANCE PVD À HAUTES PERFORMANCES MP9130 EST OPTIMISÉE POUR L'USINAGE DU TITANE

- Polyvalence des opérations (surfaçage, ramping, interpolation hélicoïdale, poches, ...)
- Optimale pour les opérations à grand porte-à-faux
- Faible prise de puissance

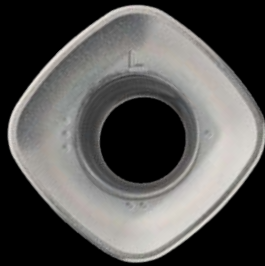

BRISE-COPEAUX L

Efforts de coupe réduits, pour les pièces de faible raideur et les machines à faible puissance.



BRISE-COPEAUX M

Première préconisation - équilibre optimal entre acuité et résistance d'arête.

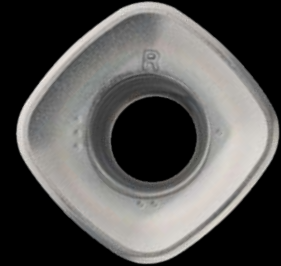

BRISE-COPEAUX R

Grande résistance d'arête - pour les applications à forte interruption de coupe ou les croûtes de forge et de fonderie.



Haute productivité et faible prise de puissance

- Prise de puissance réduite
- Réduction des efforts de coupe radiaux
- Grande fiabilité et durée de vie dans les inox et titane
- Plaquette épaisse à 4 arêtes pour une grande efficacité

415SD (MPLUS)



FRAISE À GRANDE AVANCE

S



415SD

GAMP : 9°

GAMF : 5° - 6°

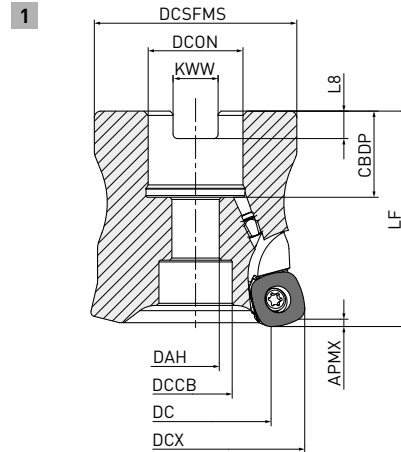

Corps à droite uniquement.

DCX	Vis d'attachement	Géométrie
Ø 50, Ø 52	HSC10035	
Ø 63, Ø 66	HSC12035	

ATTACHEMENT PAR ALÉSAGE

Référence	Stock	APMX	DC	DCON	DCX	LF	RMPX	WT	ZEFP	Type	
415SD-050A04AR-E	●	2	33.4	22	50	50	3°	0.4	4	1	SDMT12
415SD-050A05AR-E	●	2	33.4	22	50	50	3°	0.4	5	1	
415SD-052A04AR-E	●	2	35.4	22	52	50	3°	0.4	4	1	
415SD-052A06AR-E	●	2	35.4	22	52	50	3°	0.4	6	1	
415SD-063X05AR-E	●	2	46.5	27	63	50	2°	0.7	5	1	
415SD-063X07AR-E	●	2	46.5	27	63	50	2°	0.7	7	1	
415SD-066X05AR-E	●	2	49.4	27	66	50	1.9°	0.7	5	1	
415SD-066X07AR-E	●	2	49.4	27	66	50	1.9°	0.7	7	1	

1. Veuillez vous référer à 144 pour la profondeur de coupe maximale (APMX).

144

415SD (MPLUS)



FRAISE À GRANDE AVANCE





DIMENSIONS DE MONTAGE

Référence	CBDP	DAH	DCCB	DCON	DCSFMS	DCX	KWW	L8	Type
415SD-050A04AR-E	20	11	17	22	47	50	10.4	6.3	1
415SD-050A05AR-E	20	11	17	22	47	50	10.4	6.3	1
415SD-052A04AR-E	20	11	17	22	47	52	10.4	6.3	1
415SD-052A06AR-E	20	11	17	22	47	52	10.4	6.3	1
415SD-063X05AR-E	22	13	19	27	60	63	12.4	7.0	1
415SD-063X07AR-E	22	13	19	27	60	63	12.4	7.0	1
415SD-066X05AR-E	22	13	19	27	60	66	12.4	7.0	1
415SD-066X07AR-E	22	13	19	27	60	66	12.4	7.0	1

PLAQUETTES

Référence	Brise-copeaux	MP9130	IC	S	RE	Visuel
SDMT125530ZEN-L MP9130	L	●	12.25	5.56	3.0	
SDMT125530ZEN-M MP9130	M	●	12.25	5.56	3.0	
SDMT125530ZEN-R MP9130	R	●	12.25	5.56	3.0	

PIÈCES DÉTACHÉES

Référence porte-outil	 Vis de serrage	 Clé drapeau	 Vis de serrage	 Clé allen	 Antigrippant
415SD	TPS43	TIP15W-E	HSD04004H12	HKY20R	MK1KS

1. Couple de serrage (Nm) : **TPS43=3.5**

DES BUSES D'ARROSAGE DE DIFFÉRENTS DIAMÈTRES SONT DISPONIBLES POUR S'ADAPTER À LA PRESSION D'ARROSAGE DISPONIBLE

←Standard→

Diam.de buse	Ø0.6mm	Ø0.8mm	Ø1.2mm	Ø1.6mm
Référence	HSD04004H06	HSD04004H08	HSD04004H12	HSD04004H16

415SD (MPLUS)

CONDITIONS DE COUPE



COEFFICIENT DE CORRECTION DU PORTE-À-FAUX

	DCX	Porte-à-faux	Valeur de réglage		
			Vc	ap	fz
Attachement par alésage	50 – 66	<2.5xDCX	100%	100%	100%
		3.0xDCX	85%	100%	90%
		4.0xDCX	80%	80%	80%
		5.0xDCX	75%	75%	60%
		6.0xDCX	70%	70%	40%

COUPE LUBRIFIÉE

Matière	Propriétés	Conditions d'utilisation	Nuance	APMX	Vc		
					ae ≤ 0.5 DC	ae ≤ 0.75 DC	ae = DC
S Alliages de titane	—	● ● ✚	MP9130	≤ 1	55 (40–70)	50 (35–65)	45 (30–60)
			MP9130	≤ 2	55 (40–70)	50 (35–65)	45 (30–60)

PROFONDEUR DE PASSE/ AVANCE PAR DENT

Matière	Propriétés	Conditions de stabilité	Arrosage	Nuance	ae ≤ 0.5 DC		ae ≤ 0.75 DC		ae = DC				
					 ap	fz	 ap	fz	 ap	fz			
S Alliage de titane	—	● ●	●	MP9130	L	≤ 1	0.7 (0.5–0.9)	L	≤ 1	0.6 (0.4–0.7)	L	≤ 1	0.5 (0.3–0.6)
				MP9130	L	≤ 2	0.6 (0.4–0.8)	L	≤ 2	0.5 (0.3–0.6)	L	≤ 2	0.4 (0.2–0.5)
				MP9130	M	≤ 1	0.7 (0.5–0.9)	M	≤ 1	0.6 (0.4–0.7)	M	≤ 1	0.5 (0.3–0.6)
				MP9130	M	≤ 2	0.6 (0.4–0.8)	M	≤ 2	0.5 (0.3–0.6)	M	≤ 2	0.4 (0.2–0.5)
				MP9130	R	≤ 1	0.8 (0.6–1.0)	R	≤ 1	0.7 (0.4–0.9)	R	≤ 1	0.6 (0.4–0.8)
				MP9130	R	≤ 2	0.7 (0.5–0.9)	R	≤ 2	0.6 (0.3–0.8)	R	≤ 2	0.5 (0.3–0.7)
				MP9130	R	≤ 1	0.7 (0.5–0.9)	R	≤ 1	0.6 (0.4–0.7)	R	≤ 1	0.5 (0.3–0.6)
				MP9130	R	≤ 2	0.6 (0.4–0.8)	R	≤ 2	0.5 (0.3–0.6)	R	≤ 2	0.4 (0.2–0.5)

415SD (MPLUS)

CAPACITÉS MAXIMALES SELON L'OPÉRATION

RAMPING

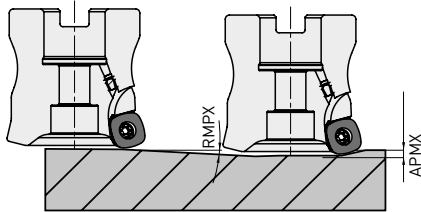

PERÇAGE HÉLICOÏDAL

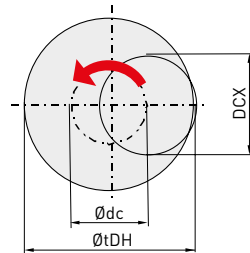

- Comment calculer l'interpolation hélicoïdale.

$$\text{ØDC} = \text{ØDH} - \text{DCX}$$

Diamètre d'interpolation Diamètre de trou désiré Diamètre de coupe max.

- Pour la profondeur de coupe par passe, consultez les conditions de coupe pour perçage hélicoïdal ci-dessus.
- Réglez la vitesse de l'axe de la machine de sorte que l'outil tourne et coupe en avalant.

- Au cours des opérations de ramping et de plongée, diminuer l'avance d'au moins 60% par rapport au taux calculé.
- Les longs copeaux engendrés peuvent se disperser, assurez-vous que des mesures de sécurité adéquates sont prises.







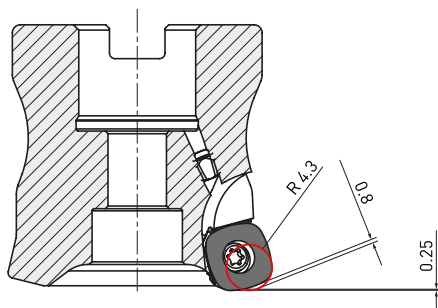



















Porte-outil Type	DCX	DC	APMX	Ramping		Perçage hélicoïdal	
				RMPX	DH		
					Min.	Max.	
ATTACHEMENT PAR ALÉSAGE							
41SD-050A04AR-E	50	33.4	2	3	84	97	
41SD-050A05AR-E	50	33.4	2	3	84	97	
41SD-052A04AR-E	52	35.4	2	3	88	101	
41SD-052A06AR-E	52	35.4	2	3	88	101	
41SD-063A05AR-E	63	46.5	2	2	110	123	
41SD-063A07AR-E	63	46.5	2	2	110	123	
41SD-066A05AR-E	66	49.4	2	1.9	116	129	
41SD-066A07AR-E	66	49.4	2	1.9	116	129	

NOTE POUR LA PROGRAMMATION

Lorsque vous utilisez 415SD (MPLUS), veuillez programmer le rayon d'outil comme suit : Les segments résiduels approximatifs pour le programme sont les suivants.



SYMBOLES

 Conditions de coupe recommandées	OPÉRATIONS		
NEW Nouveau/Extension du produit			
APPLICATION	 Ebauche		
	 Ébauche moyenne		
	 Surfaçage	 Semi-finition	
	 Chanfreinage	 Pré-finition	
	 Surfaçage-dressage rayonné	 Finition	
	 Surfaçage en poche	 Super-finition	
	 Surfacer-dresser	MATIÈRE DE L'OUTIL	
	 Fraisage épaulement		 Carbure Ultra Micro Grain Ultra micro grain carbure utilisé comme substrat.
	 Rainurage		 Nitride de bore cubique CBN Mitsubishi Materials utilisé.
	 Copiage		 Céramique Pour l'usinage haute vitesse et usinage performant des super alliés et des alliages réfractaires.
	 Ramping		 Acier rapide fritté haute dureté Acier rapide fritté haute dureté utilisé comme matériaux d'outil.
	 Rainurage rayonné		 Acier rapide nuance très alliée Haut niveau d'alliage HSS utilisé comme substrat.
	 Copiage		 Acier rapide au cobalt Cobalt Acier rapide utilisé comme substrat.
 Rainurage en T	 Acier rapide Acier rapide utilisé comme substrat.		

REVÊTEMENT



Revêtement SMART MIRACLE

Les Nouvelles technologies de revêtement lisse et dense pour le fraisage de haute efficacité des matériaux difficiles à usiner



Revêtement CRN

Revêtement CrN, nouvellement développé pour l'usinage des électrodes de cuivre et matières non-ferreuses.



Revêtement VIOLET

Vie de l'outil accrue 2 à 3 fois supérieure à celui d'un revêtement TIN basic.



Revêtement DP

Evêtement de nouvelle génération adapté pour chacun des matériaux.



Revêtement MIRACLE

Le revêtement original MIRACLE (Al, Ti)N. En outre, approprié pour l'usinage à sec.



Revêtement (Al, Ti)N

(Al,Ti)N offre une haute polyvalence.



Revêtement multicouche (Al,Ti,Cr)N

Offre une haute polyvalence pour l'acier au carbone, les alliages d'acier, et les aciers trempés.



Revêtement IMPACT MIRACLE

Technologie simple phase nano Crystal pour haute dureté et résistance thermique.



Revêtement MIRACLE

Revêtement original MIRACLE (Al,Ti)N. Adapté aussi à l'usinage à sec.



Revêtement VFR

Le revêtement PVD multicouche (AlTiSti)N est idéal pour le fraisage de matières extrêmement dures jusqu'à 70HRC.



Revêtement DLC

Dureté similaire au revêtement CVD Diamant à très haute accroche.



Revêtement Diamant

Adapté au CFRP & CFRP-Aluminium.



Revêtement Diamant

Adapté à l'usinage graphite.



Revêtement Diamant

Revêtement CVD diamant original. Adapté au perçage CFRP.



Revêtement diamant CVD

L'utilisation d'un revêtement diamant micrograins multicouches améliore considérablement la résistance à l'usure et l'état de surface.

PROPRIÉTÉS



Arête vive

Indique que la fraise a une arête vive.



Renfort de bec

Arête renforcée avec chanfrein de protection.



Angle de coupe



Angle d'hélice

Indique l'angle d'hélice de la fraise.



Angle de pointe

Indique le point d'angle à la pointe du foret. Par exemple 140° est affiché.



Profil Ebauche



Hélice variable



Creux de dent rayonné



Angle de coupe

Par exemple 90° est affiché.

AMINCISSEMENT DE L'ÂME



Type X

Amincissement X utilisé à la pointe du foret.



Type XR

Amincissement XR utilisé à la pointe du foret.



Type S

Coupe facile. Cette forme est généralement utilisée.



Type N

Efficace quand l'amincissement est épais.



Brise-copeaux

SYMBOLES

TOLÉRANCE



Tolérance de l'angle de cône
Indique la tolérance de l'angle de cône.



Tolérance R
Indique la tolérance radiale de la fraise boule.



Tolérance R
Indique la tolérance radiale du rayon d'une fraise.



Tolérance R
Indique la tolérance radiale du rayon.



Diamètre extérieur
Indique la tolérance de diamètre extérieur de la fraise.



Tolérance de pointe
Indique la tolérance du diamètre de pointe.



Tolérance de diamètre de queue
Indique la tolérance de diamètre de queue.



Tolérance de diamètre de queue
Indique la tolérance de diamètre de queue.



Tolérance foret / diamètre

ARROSAGE



Externe



Interne



Interne



Arrosage central interne



Arrosage interne radial



Arrosage interne



Arrosage interne

MITSUBISHI MATERIALS CORPORATION

GERMANY

MMC HARTMETALL GMBH
Comeniusstr. 2 . 40670 Meerbusch
Phone +49 2159 91890 . Fax +49 2159 918966
Email admin@mmchg.de

U.K.

MMC HARDMETAL U.K. LTD.
Mitsubishi House . Galena Close . Tamworth . Staffs. B77 4AS
Phone +44 1827 312312
Email sales@mitsubishicarbide.co.uk

SPAIN

MITSUBISHI MATERIALS ESPAÑA, S.A.
Calle Emperador 2 . 46136 Museros/Valencia
Phone +34 96 1441711 . Fax +34 96 1443786
Email comercial@mmevalencia.es

FRANCE

MMC METAL FRANCE S.A.R.L.
6, Rue Jacques Monod . 91400 Orsay
Phone +33 1 69 35 53 53 . Fax +33 1 69 35 53 50
Email mmfsales@mmc-metal-france.fr

POLAND

MMC HARDMETAL POLAND SP. Z O.O
Al. Armii Krajowej 61 . 50 - 541 Wrocław
Phone +48 71335 1620 . Fax +48 71335 1621
Email sales@mitsubishicarbide.com.pl

ITALY

MMC ITALIA S.R.L.
Viale Certosa 144 . 20156 Milano
Phone +39 0293 77031 . Fax +39 0293 589093
Email info@mmc-italia.it

TURKEY

MMC HARTMETALL GMBH ALMANYA - İZMİR MERKEZ ŞUBESİ
Adalet Mahallesi Anadolu Caddesi No: 41-1 . 15001 35530 Bayraklı/İzmir
Phone +90 232 5015000 . Fax +90 232 5015007
Email info@mmchg.com.tr

www.mmc-carbide.com